

Receptacle Assembly



100 A Assemblies

With AJ Back Boxes ‡ and Angle Adapters
See Note

Style 1

Description	Hub Size	Spring Door Cat. # ①
2-wire, } 2-pole }	1¼	AREA10214
	1½	AREA10215
3-wire, } 3-pole }	1¼	AREA10314
	1½	AREA10315
4-wire, } 4-pole }	1½	AREA10415
	2	AREA10416

Style 2

2-wire, } 3-pole }	1¼	AREA10324
	1½	AREA10325
3-wire, } 4-pole }	1½	AREA10425
	2	AREA10426

Receptacle



**Receptacle
Housings Only**

Style 1

Spring Door Cat. # ①	Threaded Cap Only Cat. #
AR1021	AR1027
AR1031	AR1037
AR1041	AR1047

Style 2

AR1032	AR1038
AR1042	AR1048

① For threaded cap to use in place of spring door, see page 957. Order QE covers separately.

Industrial Heavy Duty Non-Hazardous Areas

Application:

Arktite circuit breaking plugs and receptacles are used:

- to supply power to portable electrically operated devices such as motor-generator sets, compressors, heating and cooling units, welders, conveyors, lighting systems and similar equipment
- where temporary power is needed, such as at trailers, building units, heavy machinery and similar equipment
- wherever electrical loads must be quickly disconnected from power source
- in a typical installation, where a large machine utilizes a number of electrical motor drives and for ease of adjustment, removal, maintenance and replacement, each motor is connected by portable cord and Arktite receptacles rather than permanently wired
- in areas where dust, dirt, moisture and corrosion are a problem
- indoors and outdoors in non-hazardous areas of chemical plants, process industry facilities, meat packing plants, manufacturing plants and similar industrial locations

Features:

- Circuit breaking: Plugs through 200 ampere rating may be disconnected under load; 400 ampere units are for service disconnect use only.
- Receptacles accept only plugs of the same amperage rating, style and number of poles, making it impossible to mismatch, and provides for positive polarization.
- Extra wide electrical spacing allows for maximum safety.
- Insulator materials are the result of intensive testing. Selection has been made based on highest dielectric strength, maximum mechanical and impact resistance, lowest moisture absorption and highest arc tracking resistance.
- A variety of installations is possible due to the availability of several types of back boxes.
- Designed to withstand rough usage and the effects of adverse environments.
- Reversible interiors, 30, 60 and 100 ampere (except 30 and 60 ampere, 5-pole) Arktite plug and receptacle interiors are interchangeable using a screwdriver. This makes it possible to feed a normally deenergized receptacle from an energized plug with usual Arktite safety; no energized contacts are exposed.
- Additional features are indicated in the view at right:
 - 1 Grounding contact in Style 2 is bonded to the receptacle housing.
 - 2 Easily wired interior assemblies in receptacles and plugs. See table on page 938 for type of contacts in units.
 - 3 Arktite Style 2, illustrated here, has an extra grounding contact which forms a parallel circuit with the circuit formed by the plug sleeve and receptacle detent spring, and assures continuity of the grounding

safety circuit under severe service. Grounding contact is no longer than the others, so grounding circuit is made first and broken last.

4 The arc formed by pulling the plug is instantly snuffed in the deep, confined insulated arcing chamber while the plug contact is still a considerable distance inside. The arc cannot travel over to the other side of the circuit or to the housing.

5 Detent spring forms a grounding path from plug sleeve to receptacle housing. Arktite plugs and receptacles are made in two styles. With either style, the portable appliance is grounded before it is energized and remains grounded until after it is deenergized. (Arktite Style 1, not

illustrated here, is for conditions where it is desired to use the contact of the plug sleeve with the detent spring to complete the grounding safety circuit. The extra grounding conductor in the portable cable is connected to the plug sleeve by a pressure connector.)

- 6 Each plug contact fits closely the opening of its individual arcing chamber.
- 7 Grounding contact is bonded to the plug sleeve. Grounding contact is keyed to its proper location to prevent mispolarization.
- 8 Arktite connectors' gasketing system provides unsurpassed watertight integrity.
- 9 All-aluminum UNI-SHELL™ threaded construction provides added strength to withstand extreme physical abuse.

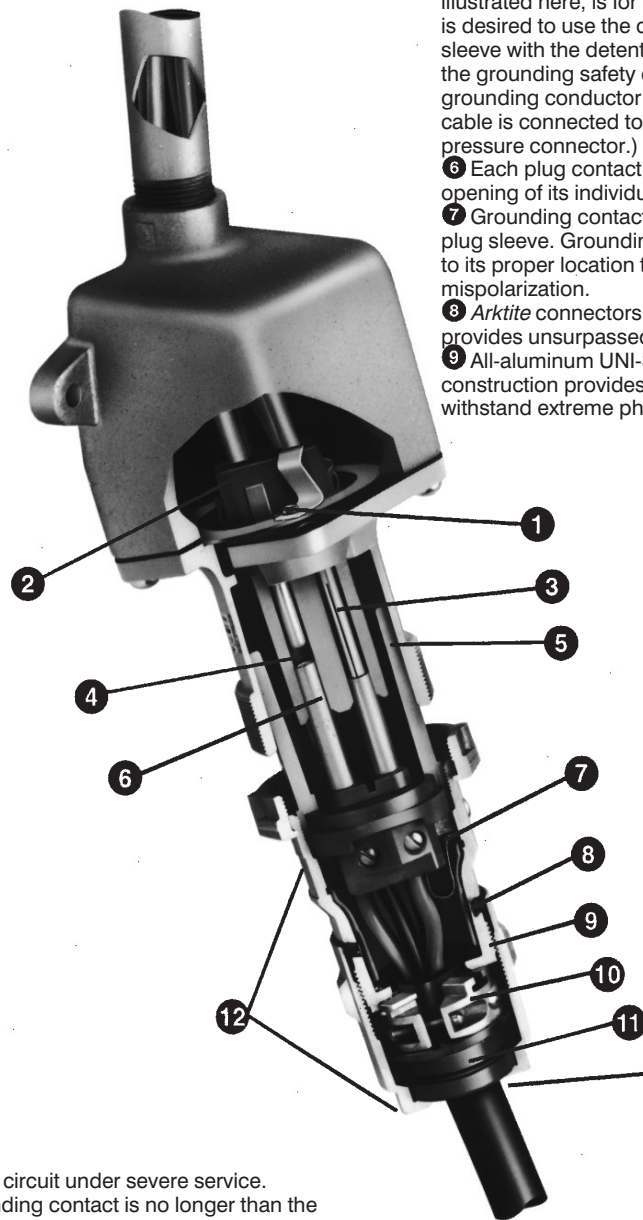

NEW!
NEMA 4
Rating

Arktite Style 2
60 ampere

NEW!
Smaller
Cable
Range

10 Arktite's TRI-LOCK™ cable grip has three clamps that tighten around the cable to securely lock it in place, even when subjected to extreme flexing and jerking.

11 The unique SURE-SEAL™ cable gland provides a complete environmental seal by distributing pressure equally around the circumference of the cable.

12 Wrenching surfaces make Arktite connector quick and easy to assemble.

Arktite® Heavy Duty Circuit Breaking Plugs and Receptacles

NEMA 4 Watertight

1P

Industrial Heavy Duty Non-Hazardous Areas

Grounding:

Crouse-Hinds utilizes two methods for completing the grounding circuit in plugs and receptacles (See diagrams below). Refer to National Electrical Code Article 250.

Style 1:

A Style 1 plug is one in which the grounding conductor in the flexible cable is bonded to the plug sleeve by a pressure connector. A Style 1 receptacle is one which is grounded by virtue of the fact that it is an integral part of a grounded conduit system. On insertion, the plug sleeve makes contact with detent springs of the grounded receptacle housing

before line and load poles engage, and on withdrawal, remains in contact until after line and load poles disengage. Therefore, exposed metal parts of the portable equipment or plug are suitably grounded.

Style 2:

A Style 2 metallic housing plug is one in which the grounding conductor in the flexible cable is bonded to the extra (grounding) pole and metal plug sleeve by a pressure connector. A Style 2 metallic housing receptacle is one in which the extra (grounding) pole is electrically connected to the equipment grounding conductor and the metal receptacle housing which itself is

grounded by virtue of the fact that it is an integral part of a grounded conduit system. In Style 2, non-metallic housing plugs and receptacles, the extra pole is used for grounding since the housings are non-conductive. In a Style 2 receptacle, the grounding connection is made before line and load poles engage, and is broken after the line load poles disengage. Furthermore, upon insertion, the plug sleeve of metal shelled units, makes contact with detent springs of the grounded receptacle housing before line and load poles engage, and on withdrawal, remains in contact until after line and load poles disengage. Therefore, exposed metal parts of the portable equipment or plug are suitably grounded.

Corrosive Locations:

Section 300-6 of the *National Electrical Code/Canadian Electrical Code* requires that, under conditions favorable to corrosion, all equipment, including enclosures and conduit, be protected against corrosion since they form an essential grounding path. In alternating current systems, running a separate conductor, usually of copper, back to the common grounding electrode may be advisable. This may be run through the conduit containing the circuit conductors. At the receptacle, this grounding conductor should be connected to the extra (grounding) pole by the pressure connector provided for that purpose. Where such an extra grounding conductor is used, Style 2 receptacles should be used.

Standard Materials:

- Metallic receptacle housings, plug and cord connector bodies – high impact strength copper-free aluminum
- Nonmetallic receptacles, plugs and cord connectors – Krydon® fiberglass-reinforced polyester material
- Back boxes: 20, 30, 60, 100 and 200 ampere – cast aluminum; 400 ampere – Feraloy® iron alloy
- Insulation (metallic products): (2-, 3-, and 4-pole) 30, 60, 100, 200, 400 ampere – fiberglass-reinforced polyester; 20, 30 ampere (5-pole) – melamine
- Contacts: pressure, solder, binding screw – brass; crimp/solder – leaded red brass; 20, 30, 60, 100 ampere – tellurium copper; 200, 400 ampere

Standard Finishes:

- Feraloy—electrogalvanized and aluminum acrylic paint
- Aluminum – natural
- Krydon fiberglass-reinforced polyester material – grey
- Fiberglass-reinforced polyester insulation – (red)
- Melamine – natural (brown)
- Brass – natural
- Leaded red brass – electro-tin-plate

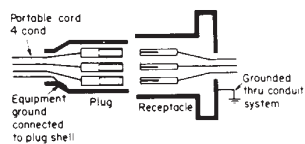
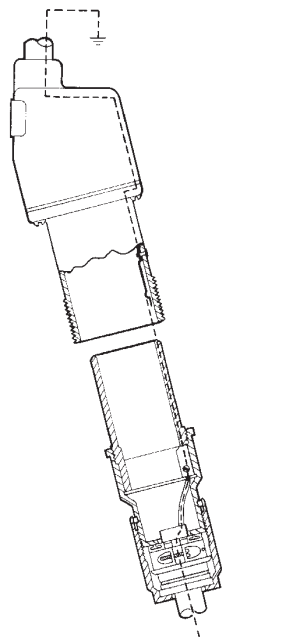

Typical 3-wire, 3-pole plug and receptacle

Style 1 units ground the portable device and the plug via the grounding conductor and the plug shell to the receptacle housing. The receptacle is grounded by virtue of its being an integral part of the conduit system.

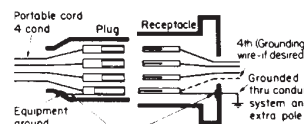
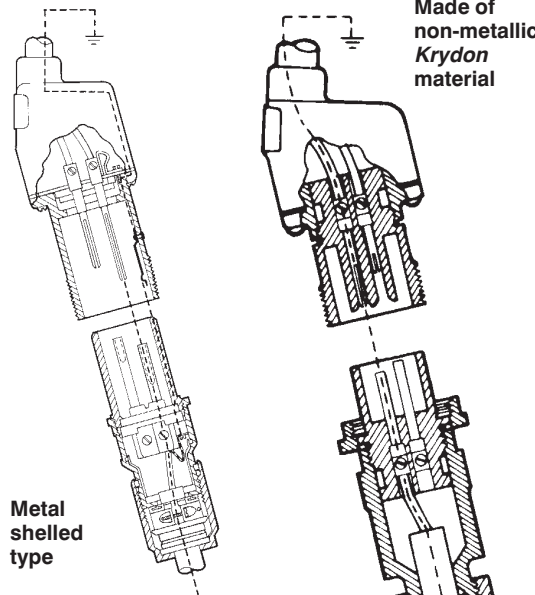

Typical 3-wire, 4-pole plug and receptacle

Style 2 units with a metallic housing have an extra (grounding) contact which forms a parallel circuit with the circuit formed by the plug sleeve and receptacle detent spring. Style 2 units with nonmetallic housings utilize the extra contact only for connecting the grounding circuit.

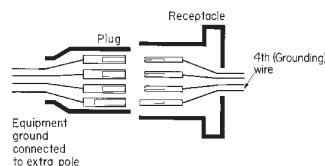

Options:

• The following special options are available from factory by adding suffix to Cat. No.:

Description	Suffix to be Added to Cat. #
Reversed contacts. Receptacle assembled with plug interior (exposed contacts), plug assembled with receptacle interior (recessed contacts). For applications where plug is energized to feed normally de-energized receptacle. Available on 30 through 400 ampere units.	S22
NOTE: 30 (2, 3, 4-pole), 60 and 100 ampere interiors can be interchanged in the field using a screwdriver. Factory conversion is required for 200 and 400 ampere products.	
Special polarity. For use where two or more receptacles of the same ampere rating, style and number of poles are to be installed in the same area for use on different voltages and/or frequencies. Prevents insertion of a plug in a receptacle with different electrical rating. Available on 20 through 400 ampere units as follows: Receptacle interior rotated 22½ degrees to right and plug changed to match (specify cable range)	S4

Accessories:

Accessories include a variety of angle adapters, panel adapters and back boxes for Arktite receptacles, listed on pages 957-959. Included are wire mesh cable grips and protective caps for Arktite plugs, listed on page 959.

Certifications and Compliances:

- UL Standards: 1682, 514; 1010 (APJ and NPJ plugs only)
- CSA Standard: C22.2 No. 182.1

Typical installation

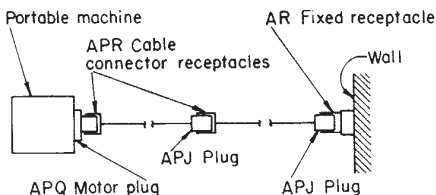

Electrical Rating Ranges:

- Voltage – 600 vac, 50 to 400 hertz; 250 vdc
- Amperes – 20, 30, 60, 100, 200 and 400

Maximum Horsepower Ratings

Electrical System	Continuous Duty Ampere Rating Plug and Receptacle	Motor Horsepower†			
		120 Volts	240 Volts	480 Volts	600 Volts
Single-phase	30	2	3	7.5	10
	60	5	10	25	20
	100	10	20		
	200	15	40		
Three-phase	30	3	5	10	10
	60	10	20	40	50
	100	15	30	40	25
	200	30	60	25	15

Wire Sizes:

The table below lists the diameter of the wire recess in Arktite plug and receptacle contacts so that maximum size of bare conductor can be figured. Range of wire sizes shown in table is intended only as a guide. Depending on type of wire used (building wire, flexible or extra flexible cable) and its construction (number and size of strands), bare copper diameters vary widely.

Diameter of Wire Recess in Plug and Receptacle Contacts

Ampere Rating	Contact Type	Diameter of Recess	Wire Size‡	
			Building	Extra Flex
20	Binding Screw	N/A	#14-#12	#14-#12
30 (2, 3, & 4-pole)	Pressure	.281	#10-#6	#10-#8
30 (2, 3, & 4-pole)	Crimp/Solder*	.180	#10-#8**	#10-#8
30 (5-pole)	Solder	.188	#12-#6	#12-#8
60 (2, 3, 4 & 5-pole)	Pressure	.312	#6-#4	#8-#4
60 (3 & 4-pole)	Crimp/Solder*	.277	#6-#4**	#8-#4
100 (2, 3 & 4-pole)	Pressure	.390	#4-#1	#4-#2
100 (3 & 4-pole)	Crimp/Solder*	.390	#2-#1**	#2-#2
200 (Std. 3 & 4-pole)	Crimp/Solder	.56	#1-4/0	#1-3/0
200 (Lg. 3 & 4-pole)	Crimp/Solder	.75	4/0-250MCM	3/0-250MCM
400 (Std. 3 & 4-pole)	Crimp/Solder	.84	250-500MCM	250-400MCM
400 (Lg. 3 & 4-pole)	Crimp/Solder	1.25	500-1000MCM	400-750MCM

* Optional—suffix "T"—see listing pages

** Smaller sizes may be used with well reducers – information on request.

† Horsepower ratings are based on Crouse-Hinds testing in which locked-rotor currents were interrupted by withdrawing the plug from the receptacle. It is highly recommended, however, that such use be limited to emergency conditions only; and that a horsepower rated switch be used for motor disconnect.

‡ Do not use wire size smaller than minimum size recommended.

§ 400A rated units are for service disconnect use only.