

Section C Switches

Index

Rating	Type	Page Number
Features and Benefits	Toggle Switch	C-3
15A, 20A & 30A, 120-277V AC	Industrial/Institutional Toggle and Lock Type	C-4
15A & 20A, 120-277V AC	Momentary Contact, Three Position, Two Circuit, Center Off	C-4
15A & 20A, 120-277V AC	Lighted Toggle	C-5
15A, 20A & 30A, 120-277V AC	Pilot Light Toggle	C-5
15A & 20A, 347V AC	Industrial/Institutional Toggle and Lock Type	C-5
15A & 20A, 120-277V AC	Construction and Commercial Toggle	C-6
15A & 20A, 120-277V AC	Style Line® Rocker, Lighted and Pilot Light	C-7
15A & 20A, 120-277V AC	Push Button PresSwitch® Switches	C-8
15A, 20A & 30A, 120-277V AC	Maintained Contact Three Position, Two Circuit, Center Off	C-9
	Incandescent Dimmers and Fan Speed Controls	C-10–11
	Panel Mount Bat Handle Switches	C-12–13
	Push Button Stations	C-14–16
30A, 40A & 60A, 600V AC	Manual Motor Controllers and Enclosures	C-17–19
30A, 60A & 100A, 600V AC	UL Type 4X Unfused Disconnect Switch	C-20
30A & 60A, 600V AC	UL Type 4X Fused Disconnect Switch	C-21–22
	Accessories	C-23–25
	Switch Technical Information	C-26
	Manual Motor Controllers Technical Information	C-27
	UL, CSA & Fed. Spec. Listing Data	C-28
	Dimmer Ganging and Derating Chart	C-29
	Toggle Switch Wiring Diagrams	C-30–31
	Disconnect Switch Technical Information	C-32

AC Switches

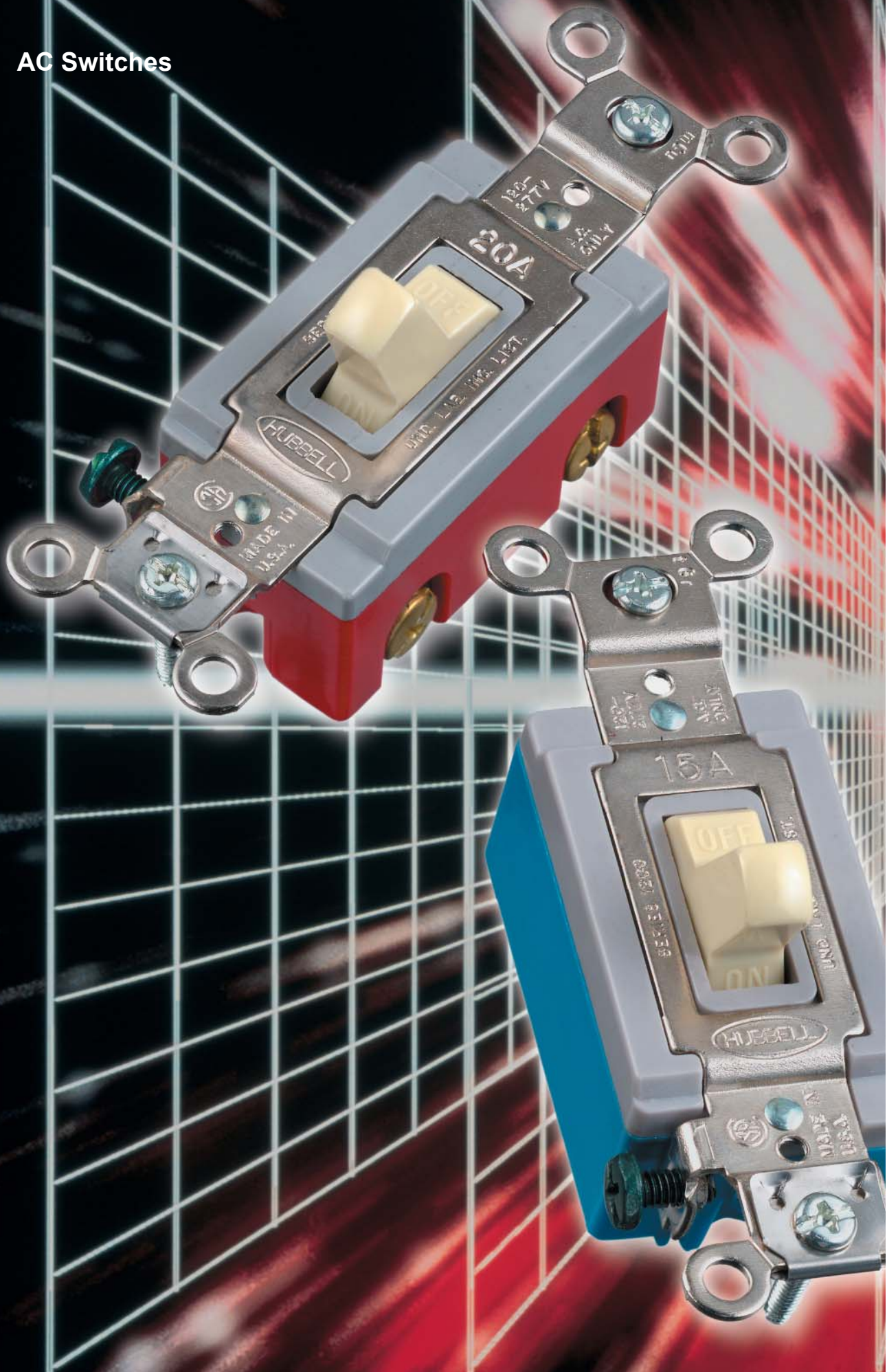

AC Toggle Switches Industrial/Institutional – Heavy Duty

Features and Benefits

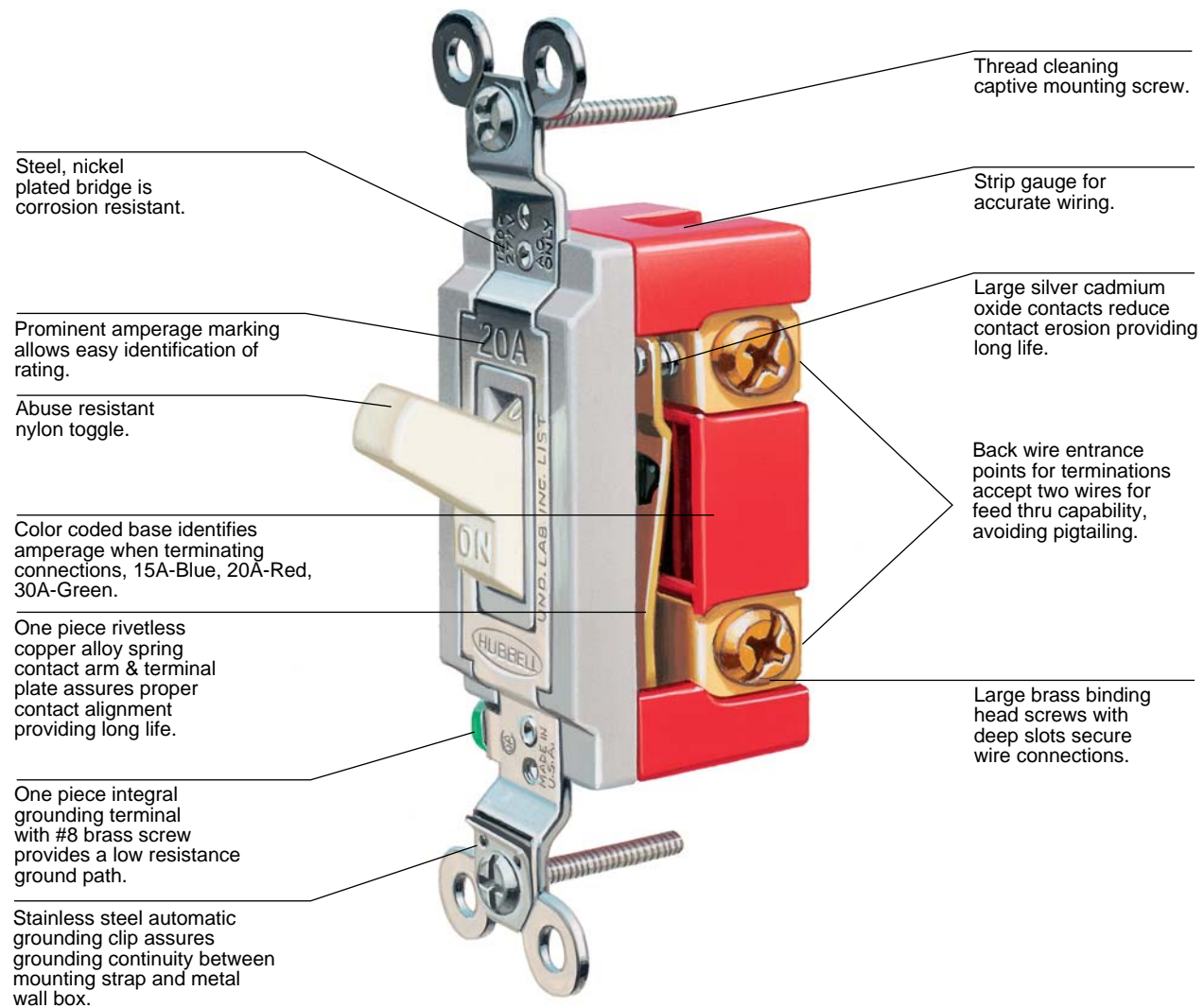

One piece rivetless copper alloy spring contact arm and terminal plate assures proper contact alignment reducing heat rise. Large silver cadmium oxide contacts reduce contact erosion and prevent welding, providing long life.



Thermoplastic elastomer rocker assures precise alignment of carbon steel coil compression spring. Permanently lubricated assembly provides long life and trouble free operation.



Heavy duty nylon toggle resists abuse and chemical attack making it suitable for use in the toughest environments.



One piece integral grounding terminal with #8 brass screw allows compliance to NEC®. Stainless steel automatic grounding clip assures grounding continuity between mounting strap and metal wall box. Steel nickel plated mounting strap provides a corrosion resistant finish.

AC Switches 15, 20 and 30 Ampere, 120-277 Volts AC

Industrial – Institutional, Heavy Duty Specification Grade
Toggle and Lock Type AC Switches with Ground Screw

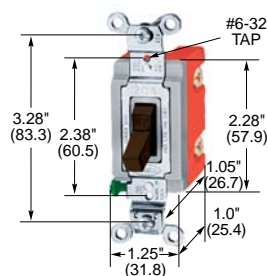

HBL1221

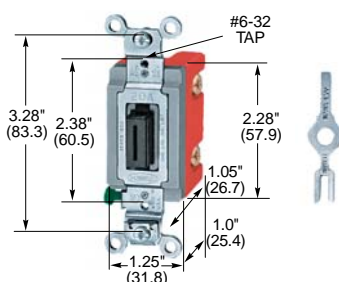

HBL1221L and Key

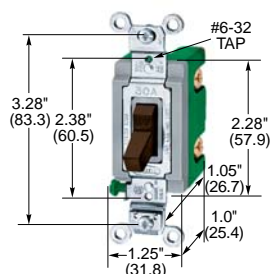

HBL3031

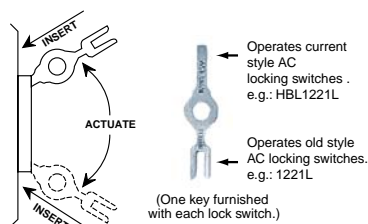

HBL1209

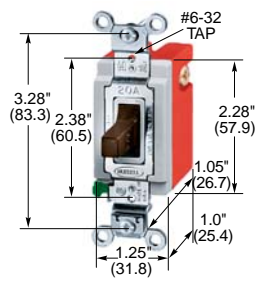

HBL1557



Specification Grade AC Switches, Back and Side Wired 15A, 120-277V AC

Description	Catalog Numbers			
	Single Pole	Double Pole	Three Way	Four Way
Brown nylon toggle.	HBL1201	HBL1202	HBL1203	HBL1204
Ivory nylon toggle.	HBL1201I	HBL1202I	HBL1203I	HBL1204I
Gray nylon toggle.	HBL1201GY	–	HBL1203GY	HBL1204GY
White nylon toggle.	HBL1201W	–	–	–
Red nylon toggle.	HBL1201R	–	–	–
Lock type.	HBL1201L**	HBL1202L**	HBL1203L**	HBL1204L**
Key for lock switches.	HBL1209*			

20A, 120-277V AC

Description	Catalog Numbers			
	Single Pole	Double Pole	Three Way	Four Way
Brown nylon toggle.	HBL1221	HBL1222	HBL1223	HBL1224
Ivory nylon toggle.	HBL1221I	HBL1222I	HBL1223I	HBL1224I
Gray nylon toggle.	HBL1221GY	HBL1222GY	HBL1223GY	HBL1224GY
White nylon toggle.	HBL1221W	HBL1222W	HBL1223W	HBL1224W
Red nylon toggle.	HBL1221R	HBL1222R	HBL1223R	HBL1224R
Black nylon toggle.	HBL1221BK	HBL1222BK	HBL1223BK	HBL1224BK
Lock type.	HBL1221L**	HBL1222L**	HBL1223L**	HBL1224L**
Key for lock switches.	HBL1209*			

30A, 120-277V AC

Description	Catalog Numbers		
	Single Pole	Double Pole	Three Way
Brown nylon toggle.	HBL3031	HBL3032	HBL3033
Ivory nylon toggle.	HBL3031I	HBL3032I	HBL3033I

Momentary Contact, Specification Grade, Back and Side Wired Three Position, Two Circuit, Center Off. UL & CSA Only

Description	Catalog Numbers	
	15A, 120-277V AC	20A, 120-277V AC
Brown nylon toggle.	HBL1556	HBL1557
Ivory nylon toggle.	HBL1556I	HBL1557I
Gray nylon toggle.	HBL1556GY	HBL1557GY
Red nylon toggle.	HBL1556R	–
White nylon toggle.	–	HBL1557W
Lock type.	HBL1556L	HBL1557L
Key for lock switches.	HBL1209*	

Notes: Keys are supplied with each lock switch. For extra keys order HBL1209.

For technical data see page C-26.

See Section K for wall plates. For accessories see pages C-23–C-25.

See pages C-30 and C-31 for wiring diagrams.

* Not UL Listed, CSA Certified

** Not Fed Spec

HP Conversion Chart

	120V	208V	240V	277VAC
15A	.5 HP	1.5HP	2HP	2HP
20A	1 HP	2HP	2HP	2HP
30A	2HP	2HP	2HP	2HP

AC Switches

15, 20 and 30 Ampere, 120-277 Volts AC

Industrial – Institutional, Heavy Duty Specification Grade

Toggle Type Lighted and Pilot Light AC Switches with Ground Screw

**Specification Grade, Lighted and Pilot Light Toggle Switches, Back and Side Wired****Lighted Toggle (light on with load off)**

Rating	Description	Catalog Numbers		
		Single Pole	Double Pole	Three Way
15A 120-277V AC	Ivory nylon toggle.	HBL1201IL	–	HBL1203IL
20A 120-277V AC	Ivory nylon toggle.	HBL1221IL	–	HBL1223IL
20A 120-277V AC	Clear polycarbonate toggle.	HBL1221ILC	–	HBL1223ILC

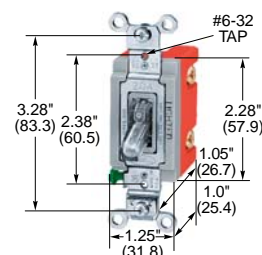

HBL1221ILC

Pilot Light (light on with load on)

Rating	Description	Catalog Numbers		
		Single Pole	Double Pole	Three Way
15A 120-277V AC	Red polycarbonate toggle.	HBL1201PL	–	HBL1203PL
20A 120-277V AC	Red polycarbonate toggle.	HBL1221PL	HBL1222PL	HBL1223PL
20A 120-277V AC	Clear polycarbonate toggle.	HBL1221PLC	–	HBL1223PLC
20A 120-277V AC	Green polycarbonate toggle.	HBL1221PLG	–	–
30A 120-277V AC	Red polycarbonate toggle.	HBL3031PL	HBL3032PL	–

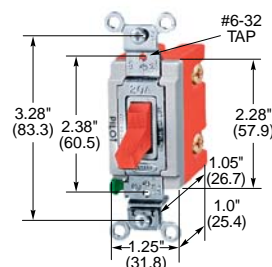

HBL1221PL

15A, 347V AC

only

Description	Catalog Numbers			
	Single Pole	Double Pole	Three Way	Four Way
Brown nylon toggle.	HBL18201CN	–	HBL18203CN	–
Ivory nylon toggle.	HBL18201CN	–	HBL18203CN	HBL18204CN
Lock type.	HBL18201LCN	–	HBL18203LCN	–

Key for lock switches. HBL1209

20A, 347V AC

only

Description	Catalog Numbers			
	Single Pole	Double Pole	Three Way	Four Way
Brown nylon toggle.	HBL18221CN	–	HBL18223CN	–
Ivory nylon toggle.	HBL18221CN	–	HBL18223CN	–

Notes: Keys are supplied with each lock switch. For extra keys order HBL1209.

For technical data see page C-26.

See Section K for wallplates. For accessories see pages C-23 to C-25.

See pages C-30 and C-31 for wiring diagrams.

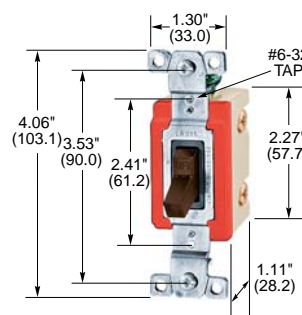

HBL18221CN

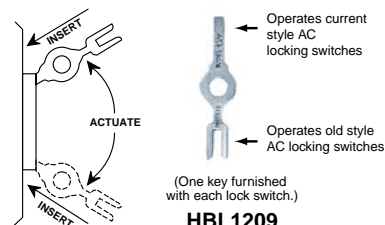

HBL1209

HP Conversion Chart

	120V	208V	240V	277VAC
15A	.5 HP	1.5HP	2HP	2HP
20A	1 HP	2HP	2HP	2HP
30A	2HP	2HP	2HP	2HP

AC Switches

15 and 20 Ampere, 120-277 Volts AC

Construction and Commercial Series Specification Grade

AC Toggle Switches with Ground Screw

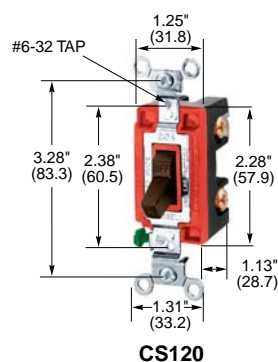
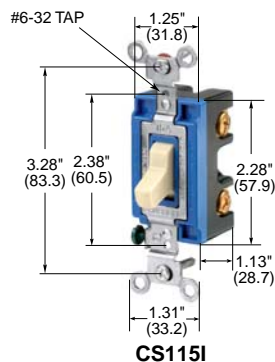
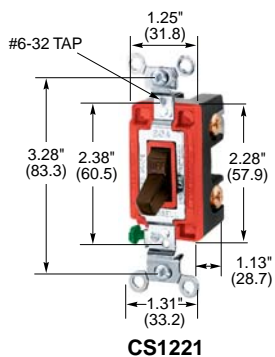
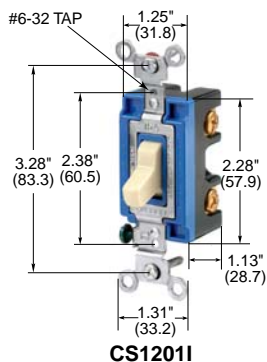

Construction Series Heavy Duty Specification Grade

AC Toggle Switches, Back and Side Wired

15A, 120-277V AC

Description	Catalog Numbers			
	Single Pole	Double Pole	Three Way	Four Way
Brown toggle.	CS1201	—	CS1203	—
Ivory toggle.	CS1201I	—	CS1203I	—
Gray toggle.	CS1201GY	—	CS1203GY	—
White toggle.	CS1201W	—	CS1203W	—
Office white toggle.	CS1201OW	—	CS1203OW	—

20A, 120-277V AC

Description	Catalog Numbers			
	Single Pole	Double Pole	Three Way	Four Way
Brown toggle.	CS1221	CS1222	CS1223	CS1224
Ivory toggle.	CS1221I	CS1222I	CS1223I	CS1224I
Gray toggle.	CS1221GY	CS1222GY	CS1223GY	CS1224GY
White toggle.	CS1221W	CS1222W	CS1223W	CS1224W
Red toggle.	CS1221R	CS1222R	CS1223R	CS1224R
Black toggle.	CS1221BK	CS1222BK	CS1223BK	CS1224BK
Office white toggle.	CS1221OW	CS1222OW	CS1223OW	CS1224OW

Commercial Series Heavy Duty Specification Grade

AC Toggle Switches, Side Wired Only.

15A, 120-277V AC

Description	Catalog Numbers			
	Single Pole	Double Pole	Three Way	Four Way
Brown toggle.	CS115	—	CS315	—
Ivory toggle.	CS115I	—	CS315I	—
Gray toggle.	CS115GY	—	CS315GY	—
White toggle.	CS115W	—	CS315W	—
Office white toggle.	CS115OW	—	CS315OW	—

20A, 120-277V AC

Description	Catalog Numbers			
	Single Pole	Double Pole	Three Way	Four Way
Brown toggle.	CS120	—	CS320	—
Ivory toggle.	CS120I	—	CS320I	—
Gray toggle.	CS120GY	—	CS320GY	—
White toggle.	CS120W	—	CS320W	—
Office white toggle.	CS120OW	—	CS320OW	—

Notes: See Section K for wall plates. See page C-30 for wiring diagrams.
For accessories see pages C-23–C-25.

HP Conversion Chart

	120V	208V	240V	277VAC
15A	.5 HP	1.5HP	2HP	2HP
20A	1 HP	2HP	2HP	2HP
30A	2HP	2HP	2HP	2HP

AC Switches

15 and 20 Ampere, 120-277 Volt AC

Style Line® Specification Grade Rocker Switches



Style Line Specification Grade AC Rocker Switches, Back and Side Wired

15A, 120-277V AC

Description	Catalog Numbers			
	Single Pole	Double Pole	Three Way	Four Way
Brown rocker.	HBL2101	–	HBL2103	–
Ivory rocker.	HBL2101I	–	HBL2103I	–
Gray rocker.	HBL2101GY	–	HBL2103GY	–
White rocker.	HBL2101WA	–	HBL2103WA	–
Black rocker.	HBL2101BK	–	HBL2103BK	–
Office white rocker.	HBL2101OW	–	HBL2103OW	–

20A, 120-277V AC

Description	Catalog Numbers			
	Single Pole	Double Pole	Three Way	Four Way
Brown rocker.	HBL2121	HBL2122	HBL2123	HBL2124
Ivory rocker.	HBL2121I	HBL2122I	HBL2123I	HBL2124I
Gray rocker.	HBL2121GY	HBL2122GY	HBL2123GY	HBL2124GY
White rocker.	HBL2121WA	HBL2122WA	HBL2123WA	HBL2124WA
Black rocker.	HBL2121BK	HBL2122BK	HBL2123BK	HBL2124BK
Office white rocker.	HBL2121OW	HBL2122OW	HBL2123OW	HBL2124OW

Style Line Specification Grade Lighted and Pilot Light AC Rocker Switches, Back and Side Wired

20A, 120V AC Lighted Rocker (light on with load off)

Description	Catalog Numbers			
	Single Pole	Double Pole	Three Way	Four Way
Ivory rocker.	HBL2121IL	–	HBL2123IL	–
White rocker.	HBL2121ILWA	–	HBL2123ILWA	–

20A, 120V AC Pilot Light Rocker (light on with load on)

Description	Catalog Numbers			
	Single Pole	Double Pole	Three Way	Four Way
Ivory rocker.	HBL2121PL	–	–	–

Note: See Section K for wall plates. See pages C-30 for wiring diagrams. For accessories see pages C-23.

HP Conversion Chart

	120V	208V	240V	277VAC
15A	.5 HP	1.5HP	2HP	2HP
20A	1 HP	2HP	2HP	2HP
30A	2HP	2HP	2HP	2HP

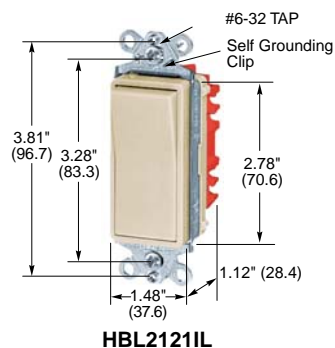
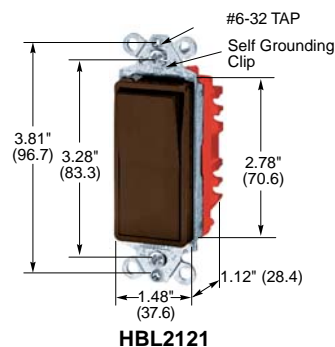

AC Switches 20 Ampere, 120-277 Volts AC

PresSwitch® Push Button Switches

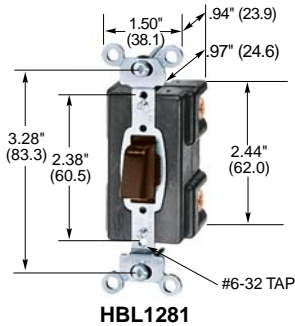

Specification Grade, Side Wired Only Standard Type

20A, 120-277V AC

Description	Catalog Numbers			
	Single Pole	Double Pole	Three Way	Four Way
Brown nylon actuator.	HBL1281	HBL1282	HBL1283*	HBL1284*
Ivory nylon actuator.	HBL1281I	HBL1282I	HBL1283I*	HBL1284I*

Momentary Type 20A, 120-277V AC

Description	Catalog Numbers			
	Single Pole	Double Pole	Three Way	Four Way
Circuit normally closed, brown.	HBL1281MC*	-	-	-
Circuit normally open, brown.	HBL1281MO*	-	-	-

Lighted and Pilot Light PresSwitches, 120V AC Lighted Actuator (light on with load off)

Description	Catalog Numbers			
	Single Pole	Double Pole	Three Way	Four Way
15A, ivory nylon actuator.	-	-	-	HBL1259I*
20A, ivory nylon actuator.	HBL1287I	-	HBL1288I*	-

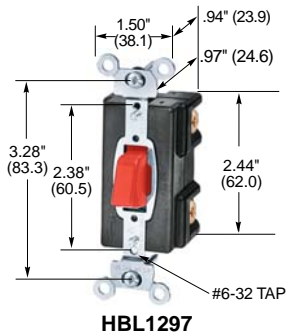

20A, 120V AC Pilot Light Actuator (light on with load on)

Description	Catalog Numbers			
	Single Pole	Double Pole	Three Way	Four Way
Red nylon actuator.	HBL1297	-	HBL1298*	-

Notes: See Section K for wallplates.
See pages C-30 and C-31 for wiring diagrams.
For accessories see pages C-23-C-25.
*Not Listed by UL or CSA.

HP Conversion Chart

	120V	208V	240V	277VAC
15A	.5 HP	1.5HP	2HP	2HP
20A	1 HP	2HP	2HP	2HP
30A	2HP	2HP	2HP	2HP

AC Switches 15, 20 and 30 Ampere, 120-277 Volts AC

Industrial – Institutional, Heavy Duty Specification Grade Three Position,
Two Circuit, Center Off, Maintained Contact Switches



**Maintained Contact, Specification Grade, Back and Side Wired,
Three Position, Two Circuit, Center Off
Single Pole, Double Throw**

Description	Catalog Numbers		
	15A 120-277V AC	20A 120-277V AC	30A 120-277V AC
Brown nylon toggle.	HBL1381	HBL1385	–
Ivory nylon toggle.	HBL1381I	HBL1385I	–
White nylon toggle.	–	HBL1385W	–

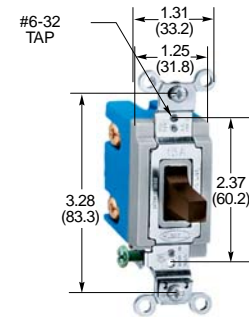

HBL1381

Double Pole, Double Throw

Description	Catalog Numbers		
	15A 120-277V AC	20A 120-277V AC	30A 120-277V AC
Brown nylon toggle.	HBL1382	HBL1386	HBL1388
Ivory nylon toggle.	HBL1382I	HBL1386I	HBL1388I
Lock type.	–	HBL1386L	–
Key for lock switches.	HBL1209		

Notes: Keys supplied with each lock switch. For extra keys order HBL1209.
See page C-31 for wiring diagrams. For accessories see pages C-23–C-25.
For technical data see page C-26.

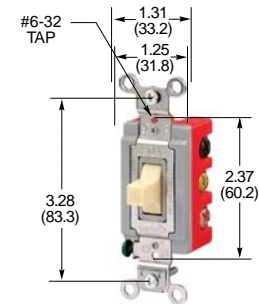

HBL1386I

AC Dimmers 600 to 2000 Watts, 120 Volts AC 60 Hz

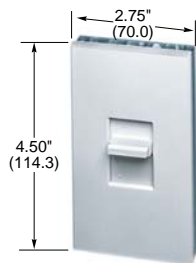

600 and 1000W Dimmer
Fits Single-Gang Wall Boxes.
AS63 and AS103

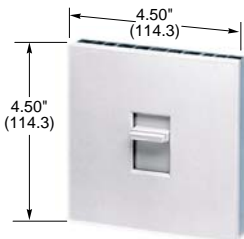

1500 and 2000W Dimmer
Fits Single-Gang Wall Boxes.
AS153 and AS203



600 and 1000W Dimmer
Fits Single-Gang Wall Boxes.
AR61 and AR101

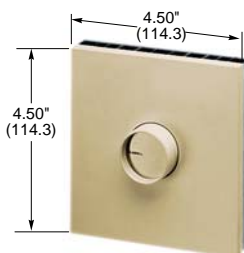

1500 and 2000W Dimmer
Fits Single-Gang Wall Boxes.
AR151 and AR201



Architectural Grade Preset Slide Control

Rating/Description	Color	Catalog Numbers
Incandescent Control 600W, 120V AC, 60 Hz, Single pole/three way - preset.	White	AS63
1000W, 120V AC, 60 Hz, Single pole/three way - preset.	White	AS103
1500W, 120V AC, 60 Hz, Single pole/three way - preset.	White	AS153
2000W, 120V AC, 60 Hz, Single pole/three way - preset.	White	AS203
Accessories Small plate kit for 600W and 1000W models. Includes non-metallic trimplate and slide.	Ivory White	AS1I AS1W
Large plate kit for 1500W and 2000W models. Includes non-metallic trimplate and slide.	Ivory White	AS2I AS2W

Note: The dimmers listed above can be wired for single pole or three way applications.

Architectural Grade Rotary Models

Rating/Description	Color	Catalog Numbers
Incandescent Control 600W, 120V AC, 60 Hz. Single pole - push on/off.	Beige	AR61
Three way - push on/off.	Beige	AR63
1000W, 120V AC, 60 Hz. Single pole - push on/off.	Beige	AR101
Three way - push on/off.	Beige	AR103
1500W, 120V AC, 60 Hz, Single pole, rotary on/off.	Beige	AR151
2000W, 120V AC, 60 Hz, Single pole, rotary on/off.	Beige	AR201
Accessories Small plate kit for 600W and 1000W models. Includes non-metallic trimplate and knob.	Beige White	AR1BE AR1W
Large plate kit for 1500W and 2000W models. Includes non-metallic trimplate and knob.	Beige White	AR2BE AR2W

Note: See page C-29 for ganging and derating.