

Cables For Large Aperture Sensors [4.6 Mm (0.187 In.)]

43GT Threaded Transmitted Beam

Cables for Large Aperture Sensors [4.6 mm (0.187 in.)]

Sensing Mode	Approximate Dimensions [mm (in.)]	Sensing Tip Material	Diameter [mm (in.)]	Sheathing Material	Sensing Distance [mm]	Cat. No.		
Transmitted Beam		Brass	3.2 (0.125)	Stainless steel		43GT-TBB25SL		
				PVC		43GT-TBB25ML		
			1.6 (0.062)	Stainless steel		43GT-TBB15SL		
				PVC		43GT-TBB15ML		
			4.0 (0.156)	Stainless steel		43GT-TBB30SL		
				PVC		43GT-TBB30ML		
		2.5 x 0.5 (0.1 x 0.02) E-W Slot	Stainless steel		43GT-TBB40SL			
			PVC		43GT-TBB40ML			
				Stainless steel	3.2 (0.125)	Stainless steel		43GT-TBS25SL
						PVC		43GT-TBS25ML
				0.7 (0.027)	Stainless steel	Stainless steel		43GT-TFS00SL
						PVC		43GT-TFS00ML
1.2 (0.046)	Stainless steel			Stainless steel		43GT-TFS10SL		
				PVC		43GT-TFS10ML		
		Stainless steel	3.2 (0.125)	Stainless steel		43GT-TYS25SL		
				PVC		43GT-TYS25ML		
				Stainless steel	0.7 (0.027)	Stainless steel		43GT-MRS00SL
						PVC		43GT-MRS00ML
				1.2 (0.046)	Stainless steel	Stainless steel		43GT-MRS10SL
						PVC		43GT-MRS10ML
		Brass/Stainless steel	1.6 (0.062)	Stainless steel		43GT-TMC15SL		
				PVC		43GT-TMC15ML		
		3.2 (0.125)	Stainless steel	Stainless steel		43GT-TMC25SL		
				PVC		43GT-TMC25ML		
				3.2 (0.125)	Stainless steel	Stainless steel		43GT-TMS25SL
						PVC		43GT-TMS25ML

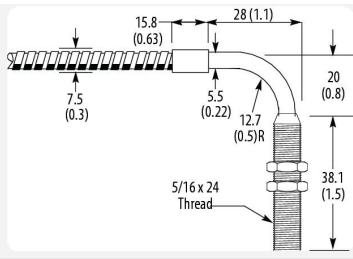

Stainless steel

4.0 (0.156)

Stainless steel

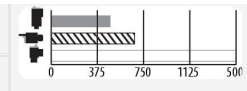

43GT-TQC30SL

PVC

43GT-TQC30ML

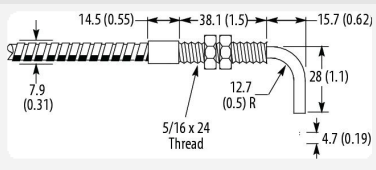

Stainless steel

3.2 (0.125)

Stainless steel

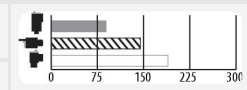

43GT-TQC25SL

PVC

43GT-TQC25ML

1.6 (0.062)

Stainless steel

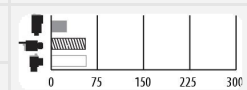

43GT-TQC15SL

PVC

43GT-TQC15ML

2.5 x 0.5 (0.1 x 0.02) E-W Slot

Stainless steel

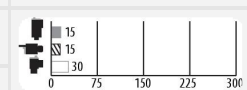

43GT-TQC40SL

PVC

43GT-TQC40ML

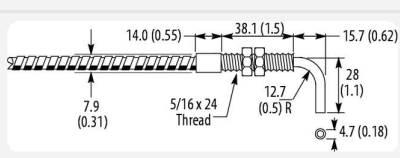

Stainless steel

3.2 (0.125)

Stainless steel



43GT-TQS25SL

PVC

43GT-TQS25ML

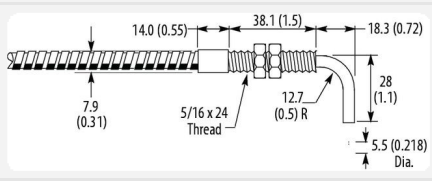

Brass/Stainless steel

4.0 (0.156)

Stainless steel



43GT-TRC30SL

PVC

43GT-TRC30ML

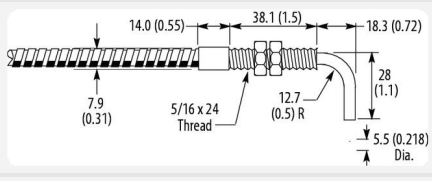

Stainless steel

4.0 (0.156)

Stainless steel



43GT-TRS30SL

PVC

43GT-TRS30ML

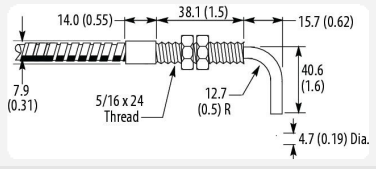

Stainless steel

3.2 (0.125)

Stainless steel

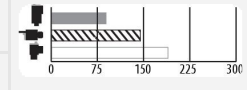

43GT-TWC25SL

PVC

43GT-TWC25ML

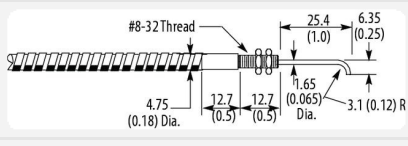

Stainless steel

1.2 (0.046)

Stainless steel

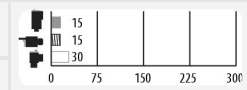

43GT-MUS10SL

PVC

43GT-MUS10ML

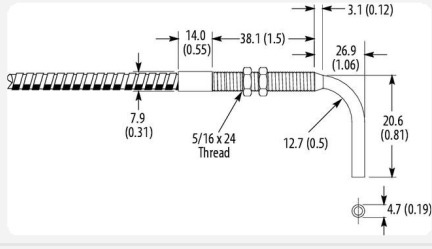

Stainless steel

3.2 (0.125)

Stainless steel



43GT-TXC25SL

PVC

43GT-TXC25ML

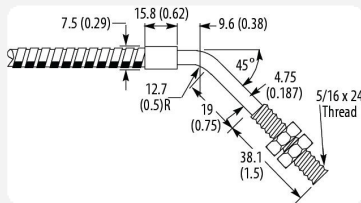

Stainless steel

3.2 (0.125)

Stainless steel



43GT-THC25SL

PVC

43GT-THC25ML

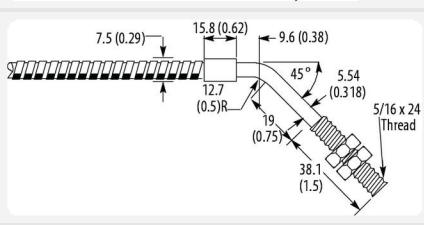

Brass/Stainless steel

4.0 (0.156)

Stainless steel

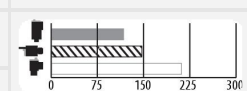

43GT-TJC30SL

PVC

43GT-TJC30ML

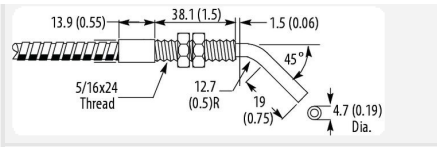

3.2 (0.125)

Stainless steel



43GT-TKC25SL

PVC

43GT-TKC25ML

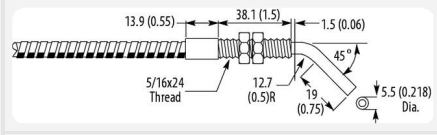

Stainless steel

4.0 (0.156)

Stainless steel

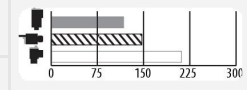

43GT-TLC30SL

PVC

43GT-TLC30ML

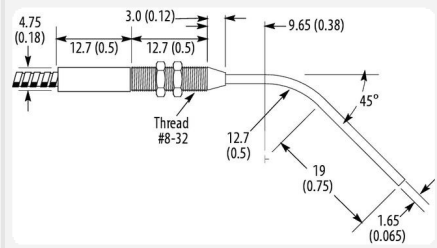

1.2 (0.046)

Stainless steel

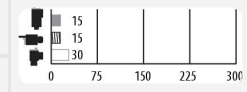

43GT-MSS10SL

PVC

43GT-MSS10ML

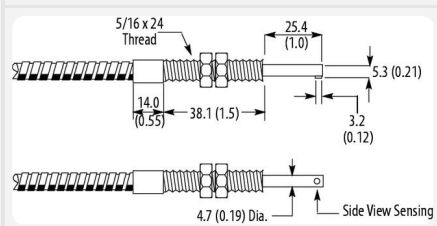

2.3 (0.090)

Stainless steel

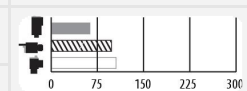

43GT-TTC20SL

PVC

43GT-TTC20ML

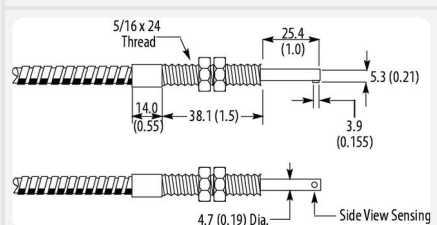

Brass/Stainless steel

2.5 x 0.5 (0.1 x 0.02) (E-W)

Stainless steel

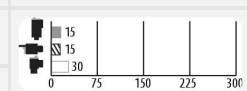

43GT-TZC40SL

PVC

43GT-TZC40ML

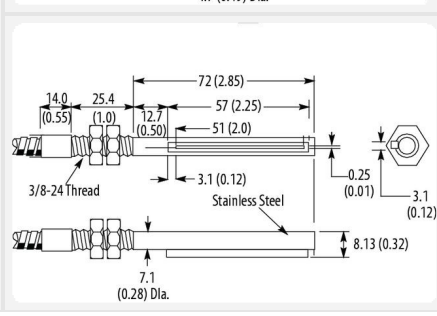

Stainless steel

51 x 0.25 (2.0 x 0.01) (N-S)

Stainless steel

Characterization not available at time of publication

43GT-TUS46SL

PVC

43GT-TUS46ML