









Cast Iron Junction Boxes

	Enclosure Style		Type 1 Type 5	Type 2	Type 3 Type 3R Type 3S	Type 4	Type 6	Type 12 Type 12K Type 13
	WYS	Surface Mounted	✓	✓	✓	✓		✓
	WYL	Surface Mounted	✓	✓	✓	✓		✓
	WYF	Surface Mounted	✓	✓	✓	✓	✓	✓
	WYW	Surface Mounted	✓	✓	✓	✓		✓
	WYR	Flush Mounted	✓	✓	✓	✓		✓
	WYU	Flush Mounted	✓	✓	✓			✓
	WYT	Sidewalk Boxes	✓	✓	✓	✓		✓
	WY58E	Sidewalk Boxes	✓	✓				

Enclosures and Junction Boxes

ENCLOSURES AND JUNCTION BOXES: ORDINARY LOCATION JUNCTION BOXES

Introduction to Cast Iron Junction Boxes

I. Purpose of Enclosure

Enclosures are used to protect personnel against accidental contact with enclosed electrical devices or connections and to protect the enclosed devices or connections against specified external conditions. They also serve as intermediate pulling and splicing points in a conduit system.

II. Design of Enclosures

Enclosures are offered in different designs and construction to permit their use in various locations and areas. These are as follows:

Non-hazardous Locations:

1. Weatherproof boxes are so constructed as to be suitable for use outdoors under normal conditions. If it is necessary to prevent the entry of water under extreme conditions of weather, boxes listed as watertight or raintight are recommended.
2. Raintight boxes are so constructed as to exclude a beating rain. All boxes in this catalog which are designated as raintight have been so listed by Underwriters Laboratories, Inc. — and CSA.
3. Watertight boxes (NEMA Type 4) are constructed to meet the requirements listed under "NEMA DATA."
4. Submersible Boxes are so constructed that they will exclude water when submerged under specified conditions of pressure and time.
5. Dust-Tight Boxes are so constructed to meet the requirements listed under "NEMA DATA".

Hazardous Locations:

Consult the Enclosures and Junction Boxes section for our complete offering.

III. Advantages of Cast Enclosures

Cast metal enclosures have the advantage over formed (fabricated) sheet metal enclosures for the following reasons:

- A. They are of one piece construction and do not have the disadvantages of spot welded seams usually found in formed sheet metal boxes.
- B. They have greater mechanical strength, have thicker walls and are suitable for drilling and tapping at the factory or in the field.
- C. They are corrosion resistant and can withstand more mechanical abuse.

IV. Cast Metals

CAST IRON BOXES will provide long life, are inherently corrosion resistant and have the lowest initial cost.

V. Finishes on Cast Enclosures

CAST IRON - The hot-dip galvanized finish which is applied to all our cast iron boxes will conform to ASTM Designation A153-73, Class A and NEMA requirements for rust-resistance.

VI. Hardware Used on Cast Enclosures

CAST IRON BOXES are furnished with Stainless Steel screws.

VII. Specification of Extras on Cast Enclosures

The type of holes to be provided for the entrance of conduit into the enclosure are defined under "Instructions for Ordering Boxes."

VIII. Specification of Extras on Cast Enclosures

The "Standard Construction" of each type of enclosure is shown on each listing. The extras which are available and must be specified are shown under "Additional Cost Items."

Cast Iron Junction Boxes — NEMA Data

Our cast junction boxes are designed, constructed and tested to comply with NEMA standards. The following chart has been prepared to provide a quick reference for selecting enclosures to meet specific NEMA requirements.

A brief description of the more common types of enclosures used by the electrical industry relating to their environmental capabilities follows. Please refer to the appropriate sections of NEMA Standards Publication No. 250-2014. Enclosures for Electrical Equipment (1000 Volts Maximum) for complete information regarding applications, features and design tests.

Definitions Pertaining to Non-hazardous Locations

- **Type 1** enclosures are intended for use primarily to provide a degree of protection against contact with the enclosed equipment.
- **Type 2** enclosures are intended for indoor use primarily to provide a degree of protection against limited amounts of falling water.
- **Type 3** Enclosures constructed for either indoor or outdoor use to provide a degree of protection to personnel against incidental contact with the enclosed equipment; to provide a degree of protection against falling dirt, rain, sleet, snow and windblown dust; and that will be undamaged by the external formation of ice on the enclosure.
- **Type 3R** enclosures are intended for outdoor use primarily to provide a degree of protection against falling rain, sleet, and external ice formation.
- **Type 3S** enclosures are intended for outdoor use primarily to provide a degree of protection against windblown dust, rain, sleet, and provide for operation of external mechanisms when ice laden.
- **Type 4** enclosures are intended for indoor or outdoor use primarily to provide a degree of protection against windblown dust and rain, splashing water, and hose-directed water.

- **Type 5** enclosures are intended for indoor use primarily to provide a degree of protection against dust and falling dirt.
- **Type 6** enclosures are intended for indoor or outdoor use primarily to provide a degree of protection against the entry of water during occasional temporary submersion at a limited depth. (30 min. @ 6 ft.)
- **Type 6P** enclosures are intended for indoor or outdoor use primarily to provide a degree of protection against the entry of water during prolonged submersion at a limited depth. (24 hrs. @ 6ft.)
- **Type 12** enclosures are intended for indoor use primarily to provide a degree of protection against dust, falling dirt, and dripping non-corrosive liquids.
- **Type 12K** enclosures with knockouts are intended for indoor use primarily to provide a degree of protection against dust, falling dirt, and dripping non-corrosive liquids other than at knockouts.
- **Type 13** enclosures are intended for indoor use primarily to provide a degree of protection against dust, spraying of water, oil, and non-corrosive coolant.

Definitions Pertaining to Hazardous (Classified) Locations

- **Type 7** enclosures are for use indoors in locations classified as Class I, Groups A, B, C, or D, as defined in the National Electrical Code. See Enclosures and Junction Boxes section.
- **Type 9** enclosures are for use in indoor locations classified in Class II, Groups E, F, or G, as defined in the National Electrical Code. Enclosures and Junction Boxes section.

Type of Enclosure	Type 1 Type 5	Type 2	Type 3 Type 3R Type 3S	Type 4	Type 6	Type 12 Type 12K Type 13
WYS	✓	✓	✓	✓		✓
WYL	✓	✓	✓	✓		✓
WYF	✓	✓	✓	✓	✓	✓
WYW	✓	✓	✓	✓		✓
WYR	✓	✓	✓	✓		✓
WYU	✓	✓	✓			✓
WYT	✓	✓	✓	✓		✓
WY58E	✓	✓				

W Series Cast Junction Box Ordering Information

Boxes Available for Raintight, Watertight, or Submersible Applications

The following information should be given on all box orders:

Catalog Number and Inside Dimensions
(L x W x D) should be specified

Sketch showing size and location of conduit entrances should be furnished similar to Drilling Template, Fig. 2. Tables give recommended spacing between conduits and minimum distance from corner and back of box. When spacings are not specified, they will be located at our discretion.

Type of Conduit Entrances (see Fig. 1, below) should be specified as follows:

1. Slip-Hole (ASH) - conduit clearance hole.
2. Drilled and Tapped hole (ADT).
3. Bossed, Drilled and Tapped hole to provide greater thread engagement (ABDT).
4. Boss only (ABWH) - for Drilling and Tapping in field. Specify conduit size.

Mounting Lugs (See Fig. 1 below) are provided on all surface mounted boxes. Boxes up to 12" x 6" have 2 mounting lugs. Larger boxes have 4 mounting lugs. All mounting lugs will be located on the long sides of the box, unless otherwise specified. Refer to W-Series Cast Box Mounting Lug data for dimensional information.

Conduit Entrances:

Slip Holes: These are clearance holes for conduit. No threads are provided. Conduits are usually fastened in slip holes by means of locknuts and bushings. *STANDARD LOCKNUT SPACINGS MUST BE ALLOWED BETWEEN THE CONDUITS.*

Drilled and Tapped Holes are threaded holes provided in the enclosure wall into which the conduit is screwed. To meet UL requirements, they must conform to the following:

1* Enclosures for use in Non-hazardous Locations must have a wall thickness of not less than 1/4" at the tapped holes for the conduit and there shall be not less than 3-1/2 threads in the metal.

* Compare the wall thickness shown in the catalog page for these enclosures with the chart below to determine the number of threads which the box wall will provide for the various conduit sizes. If more threads are required, please specify a Bossed, Drilled and Tapped hole, type ABDT.

Bossed, Drilled and Tapped Holes

are holes threaded thru the box wall and a boss (or pad) which has been added at the location of the conduit entrance to provide added wall thickness for 5 threads of engagement.

Conduit Size	Wall Inches Required in Millimeters (Inches)		
	No. of Threads Per Inch	3-1/2 Threads	5 Threads
1/2 - 3/4	14	6.35 (0.25)	0.17 (0.38)
1 - 2	11-1/2	0.14 (0.31)	0.2 (0.44)
2-1/2 - 6	8	0.2 (0.44)	0.29 (0.63)

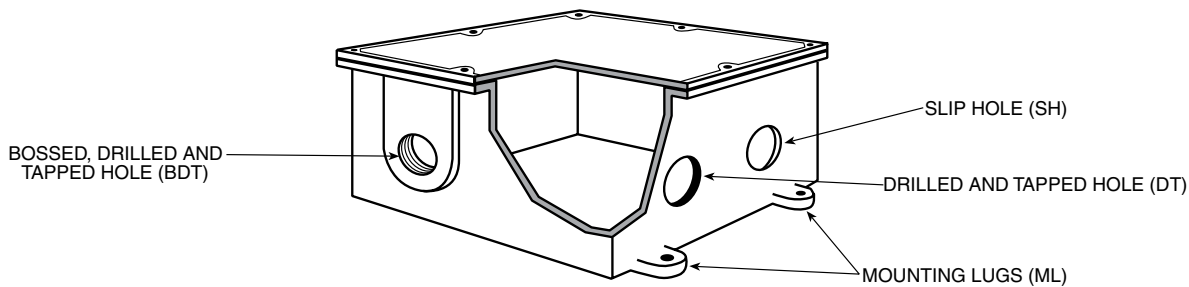

Fig. 1

W Series Cast Junction Box Ordering Information

Boxes Available for Raintight, Watertight, or Submersible Applications

Drilling Template

- View looking into box – sides laid down.
- Dimensions are always understood to be Inside Measurements unless otherwise specified.
- See Drilling Template for Junction Boxes, for copier reproduction or computer scanning.

All boxes of the Type WYS, WYL, WYW, and WYT have a post in each corner and allowance must be made for them, when conduit entrances are to be located close to a corner. Dimension "A" in the table below is the minimum distance allowable from the sidewall of these boxes to the centerline of the conduit entrance, which provides the proper clearance between a locknut and the post. The "B" dimension will provide the proper clearance between a locknut or bushing and the sidewall of all other types of boxes and between a locknut or bushing and the backs of all boxes, including Types WYS, WYL, WYW, and WYT.

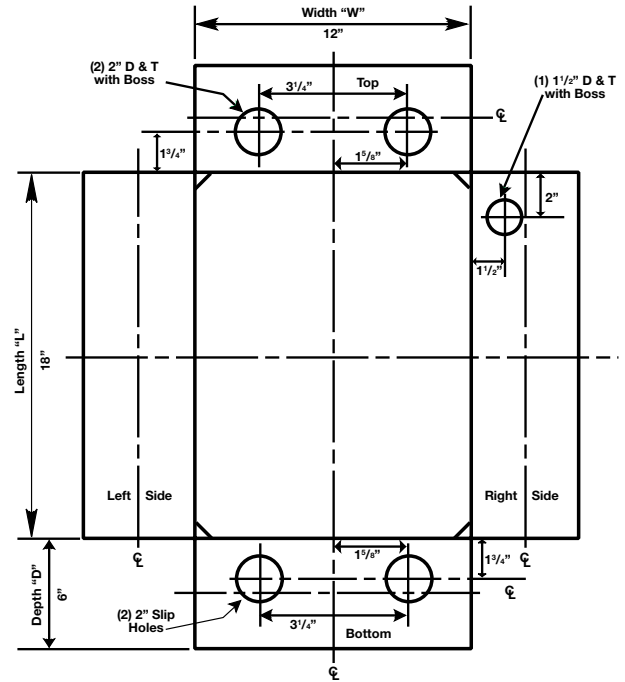
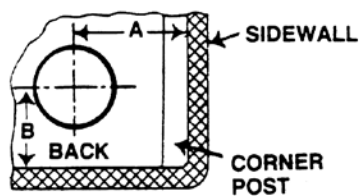

Figure 2

Minimum Allowable Spacing from Back and Sides

Allowance made for clearance over locknuts and bushings.



Types WYS, WYL, WYW, and WYT

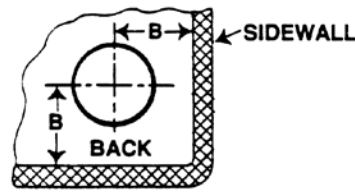

Types WYF, WYR, WYU

Conduit Size	1/2"	3/4"	1"	1-1/4"	1-1/2"	2"	2-1/2"	3"	3-1/2"	4"	5"	6"
Dimension A mm (in)	31.8 (1.25)	35.1 (1.38)	41.4 (1.63)	47.8 (1.88)	50.8 (2.00)	60.5 (2.38)	66.8 (2.63)	76.2 (3.00)	82.6 (3.25)	92.2 (3.63)	107.95 (4.25)	123.95 (4.88)
Dimension B mm (in)	25.4 (1.00)	25.4 (1.00)	28.7 (1.13)	35.1 (1.38)	38.1 (1.50)	44.5 (1.75)	54.1 (2.13)	63.5 (2.50)	73.2 (2.88)	79.5 (3.13)	95.25 (3.75)	111.25 (4.38)

W Series Cast Junction Box Ordering Information

Boxes Available for Raintight, Watertight, or Submersible Applications

Minimum Recommended Spacing Between Conduit Openings

Allowance made for clearance over locknuts and bushings.

When unions are used, additional space must be allowed. Table shows minimum distances between conduit opening centerlines in various size combinations. For example, if 1-1/2" and 3/4" openings are to be drilled and tapped into one side of box, the minimum spacing between centerlines would be 54.1 mm (2.13").

Space Between Centers of Conduit Millimeters (Inches)

Size of Conduit	Minimum Space Between Centers of Conduits ①											
	6	5	4	3-1/2	3	2-1/2	2	1-1/2	1-1/4	1	3/4	1/2
1/2	127 (5)	111.25 (4.38)	92.2 (3.63)	85.85 (3.38)	76.2 (3)	66.8 (2.63)	60.45 (2.38)	50.8 (2)	47.75 (1.88)	44.45 (1.75)	41.4 (1.63)	38.1 (1.5)
3/4	130.3 (5.13)	114.3 (4.5)	95.25 (3.75)	88.9 (3.5)	79.5 (3.13)	69.85 (2.75)	63.5 (2.5)	54.1 (2.13)	50.8 (2)	47.75 (1.88)	44.45 (1.75)	
1	133.35 (5.25)	117.6 (4.63)	101.6 (4)	92.2 (3.63)	82.55 (3.25)	76.2 (3)	66.8 (2.63)	60.45 (2.38)	57.15 (2.25)	50.8 (2)		
1-1/4	139.7 (5.5)	123.95 (4.88)	104.9 (4.13)	98.55 (3.88)	88.9 (3.5)	79.5 (3.13)	73.15 (2.88)	63.5 (2.5)	60.45 (2.38)			
1-1/2	136.65 (5.38)	127 (5)	107.95 (4.25)	101.6 (4)	92.2 (3.63)	82.55 (3.25)	76.2 (3)	66.8 (2.63)				
2	152.4 (6)	136.65 (5.38)	117.6 (4.63)	107.95 (4.25)	98.55 (3.88)	92.2 (3.63)	82.55 (3.25)					
2-1/2	158.75 (6.25)	143 (5.63)	123.95 (4.88)	117.6 (4.63)	107.95 (4.25)	98.55 (3.88)						
3	168.4 (6.63)	152.4 (6)	136.65 (5.38)	127 (5)	117.6 (4.63)							
3-1/2	177.8 (7)	158.75 (6.25)	143 (5.63)	133.35 (5.25)								
4	184.15 (7.25)	168.4 (6.63)	149.35 (5.88)									
5	203.2 (8)	184.15 (7.25)										
6	219.2 (8.63)											

① If Conduit Fittings are used additional spacing between conduits will be required. Determine spacings based on fittings being used.

W Series Cast Junction Box Drilling Template

Boxes Available for Raintight, Watertight, or Submersible Applications

DRILLING TEMPLTE for JUNCTION BOXES

For copier reproduction or computer scanning. Please send to your local representative for quotation or order confirmation.

Distributor _____ P.O. No. _____
 End User _____ Date _____
 Req. No. _____ Mark Box _____

Looking Into Box - Sides Laid Down
 All dimensions are from inside of box.

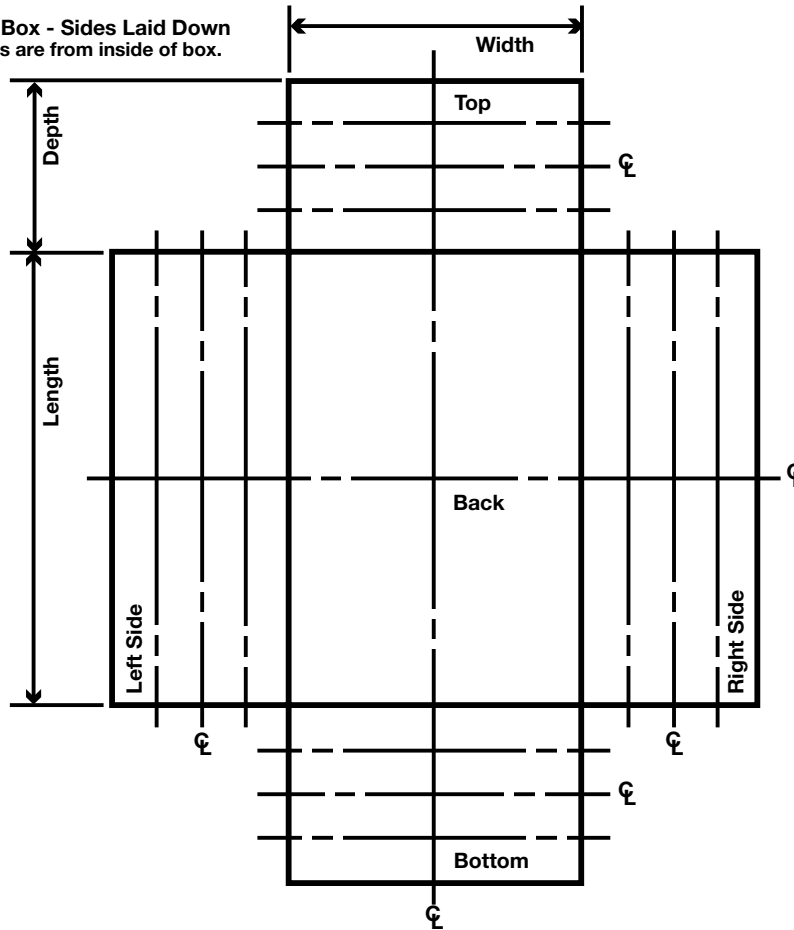

Drilling Data

NOTE: If location of openings are not definitely dimensioned, they will be located at our discretion.

Slip-hole Only Drilled and Tapped
 Drilled and Tapped with Boss Boss Only

Catalog No. _____
 Quantity _____

Mounting Lugs

NOTE: Mounting Lugs are provided on all surface-mount boxes.

Additional Specifications: _____

Dwg. No. _____

Company/Location _____

Signature _____

Print Name _____

W Series Cast Junction Box Ordering Information

Boxes Available for Raintight, Watertight, or Submersible Applications

Additional Cost Items

The table below shows the additional cost items available on the different types of enclosures shown in this catalog. These cost items are shown in the tables on the adjacent page and when not furnished as standard equipment the cost must be added to the base price of the box.

Special Equipment Consult Factory for Prices and Availability

- Lettering on Covers can be furnished. These are engraved letters and can be applied to the cover of any type box.
- Submersibility Tests can be made on our Types WYF within the limitations shown on Flat Flanged Boxes catalog page listing these enclosures.
- Certifications can be furnished if specific requirements are provided at time of order.

✓ – Available option at additional charge.

S – Furnished as standard equipment at no additional charge

NA – Not permitted on this type of enclosure by NEMA and Underwriters Laboratories, Inc. standards and specifications, or basic construction of box will not allow or require this item.

ITEM Catalog Designation	Type of Enclosure							
	WYS	WYL	WYF	WYW	WYU	WYR	WYT	WY58E
Slip Holes (ASH)	✓	✓	✓	✓	✓	✓	✓	NA
Drill and Tap Holes (ADT)	✓	✓	✓	✓	✓	✓	✓	NA
Bosses Only (ABWH)	✓	✓	✓	✓	✓	✓	✓	NA
Drilled and Tapped Boss (ABDT)	✓	✓	✓	✓	✓	✓	✓	NA
Mtg. Lugs (AML)	S	S	S	S	✓	✓	✓	NA
Mtg. Plates (AYM)	✓	✓	✓	✓	✓	✓	✓	NA
Hinges (AHNG)	NA	NA	NA	S	✓	NA	NA	NA
Drain and Breather (AMDB)	✓	✓	✓	✓	✓	NA	NA	NA

W Series Cast Junction Box Ordering Information

Boxes Available for Raintight, Watertight, or Submersible Applications

Drilling and Tapping

Applies to: Types WYS, WYL, WYF, WYW, WYT, WYU, WYR.

Conduit Size Inches	Catalog Number			
	Drilling Only Slip Hole	Drilling and Tapping No Boss	Boss Only 5 Threads without Hole	Boss for 4 Threads and Tapping
1/2	ASH-50	ADT-50	ABWH-50	ABDT-50
3/4	ASH-75	ADT-75	ABWH-75	ABDT-75
1	ASH-100	ADT-100	ABWH-100	ABDT-100
1-1/4	ASH-125	ADT-125	ABWH-125	ABDT-125
1-1/2	ASH-150	ADT-150	ABWH-150	ABDT-150
2	ASH-200	ADT-200	ABWH-200	ABDT-200
2-1/2	ASH-250	ADT-250	ABWH-250	ABDT-250
3	ASH-300	ADT-300	ABWH-300	ABDT-300
3-1/2	ASH-350	ADT-350	ABWH-350	ABDT-350
4	ASH-400	ADT-400	ABWH-400	ABDT-400
4-1/2	ASH-450	ADT-450	ABWH-450	ABDT-450
5	ASH-500	ADT-500	ABWH-500	ABDT-500
6	ASH-600	ADT-600	ABWH-600	ABDT-600

Combination Drain and Breather Fittings

D and T and installation included.

Size (Inches)	Catalog Number
3/8	AMDB-38
1/2	AMDB-50

Grounding Kits

Wire Capacity Al-Cu Tinned Copper	Catalog Number
#14-4 AWG	AGK-04
8-1/0 AWG	AGK-10
6 AWG-250kcmil	AGK-25

Letters Engraved on Box Covers

Description	Catalog Number
Up to 10 letters, one line	AENGRAVE-1
Up to 20 letters, two lines	AENGRAVE-2

Optional Mounting Lugs with Bolt Holes (Mounting Lugs are standard equipment on surface mounted boxes)

Maximum Box Size — L x W in mm (in)	No. of Lugs	Catalog Number
Sizes up to 152.4 x 101.6 (6 x 4)	2	A2-ML-0604
	4	A4-ML-0604
Sizes 152.4 x 152.4 up to 304.8 x 101.6 (6 x 6 to 12 x 4)	2	A2-ML-1204
	4	A4-ML-1204
Sizes 304.8 x 152.4 up to 457.2 x 406.4 (12 x 6 up to 18 x 16)	2	A2-ML-1816
	4	A4-ML-1816
Sizes 457.2 x 457.2 and larger (18 x 18 and larger)	4	A4-ML-3636

Hinges for WYU Boxes

Type	Box Size in Millimeters (Inches)	Number of Hinges Per Set	Catalog Number
Stainless Steel	Up to 304.8 x 304.8 (12 x 12)	2	AHNG-22SS

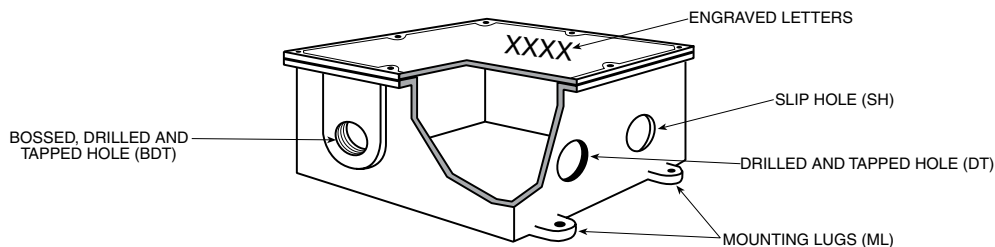

W Series Junction Box Mounting Plate Information

Boxes Available for Raintight, Watertight, or Submersible Applications

Mounting plates are used for mounting equipment up off the back of an enclosure. Steel Plates are all 3.3 mm (0.13") thick hot dip galvanized material. Aluminum plates are 3.3 mm (0.13") thick material up to and including 304.8 x 304.8 mm (12 x 12") size. All larger sizes are constructed of 4.8 mm (0.19") thick aluminum plate.

Select mounting plates based on inside length and width of box. Order as a separate item immediately following the catalog number of the box as follows:

Example: Line 1 **WYS-080804**
Line 2 **WYM-0808-2**

For mounting plates in smaller boxes than listed, use similar catalog number logic. Example: A steel mounting plate for a **WYF-040404** box would be **WYM-0404-1**. Pricing will be based upon a **WYM-0808-1** price.

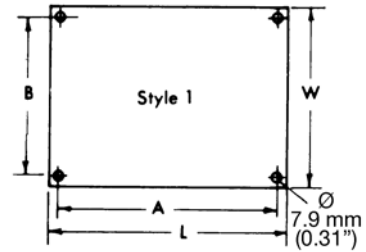

The catalog numbers shown in the table below include the mounting buttons.

Inside Length and Width of Junction Box in mm (in)	Style	Catalog Number – Steel Plates		Catalog Number – Aluminum Plates		Dimension in Millimeters (Inches)			
		For use in Types WYF and WYR Junction Boxes	For use in Types WYS, WYL and WYW Junction Boxes	For use in Types WYF and WYR Junction Boxes	For use in Types WYS, WYL and WYW Junction Boxes	L	W	A	B
203.2 x 203.2 (8 x 8)	1	WYM-0808-1		WYM-0808-1A		171.5 (6.75)	171.5 (6.75)	152.4 (6.00)	152.4 (6.00)
			WYM-0808-2		WYM-0808-2A	152.4 (6.00)	152.4 (6.00)	133.4 (5.25)	133.4 (5.25)
254.0 x 203.2 (10 x 8)	1	WYM-1008-1		WYM-1008-1A		222.3 (8.75)	171.5 (6.75)	203.2 (8.00)	203.2 (8.00)
			WYM-1008-2		WYM-1008-2A	203.2 (8.00)	152.4 (6.00)	184.2 (7.25)	133.4 (5.25)
254.0 x 254.0 (10 x 10)	1	WYM-1010-1		WYM-1010-1A		222.3 (8.75)	222.3 (8.75)	203.2 (8.00)	203.2 (8.00)
			WYM-1010-2		WYM-1010-2A	203.2 (8.00)	203.2 (8.00)	184.2 (7.25)	184.2 (7.25)
304.8 x 203.2 (12 x 8)	1	WYM-1208-1		WYM-1208-1A		273.1 (10.75)	171.5 (6.75)	254.0 (10.00)	152.4 (6.00)
			WYM-1208-2		WYM-1208-2A	254.0 (10.00)	152.4 (6.00)	235.0 (9.25)	133.4 (5.25)
304.8 x 254.0 (12 x 10)	1	WYM-1210-1		WYM-1210-1A		273.1 (10.75)	222.3 (8.75)	254.0 (10.00)	203.2 (8.00)
			WYM-1210-2		WYM-1210-2A	254.0 (10.00)	203.2 (8.00)	235.0 (9.25)	133.4 (5.25)
304.8 x 304.8 (12 x 12)	1	WYM-1212-1		WYM-1212-1A		273.1 (10.75)	273.1 (10.75)	254.0 (10.00)	254.0 (10.00)
			WYM-1212-2		WYM-1212-2A	254.0 (10.00)	254.0 (10.00)	235.0 (9.25)	235.0 (9.25)
355.6 x 203.2 (14 x 8)	1	WYM-1408-1		WYM-1408-1A		323.9 (12.75)	171.5 (6.75)	304.8 (12.00)	152.4 (6.00)
			WYM-1408-2		WYM-1408-2A	304.8 (12.00)	152.4 (6.00)	285.5 (11.25)	133.4 (5.25)
355.6 x 355.6 (14 x 14)	1	WYM-1414-1		WYM-1414-1A		323.9 (12.75)	323.9 (12.75)	304.8 (12.00)	304.8 (12.00)
			WYM-1414-2		WYM-1414-2A	304.8 (12.00)	304.8 (12.00)	285.5 (11.25)	285.5 (11.25)
406.4 x 203.2 (16 x 8)	1	WYM-1608-1		WYM-1608-1A		374.7 (14.75)	171.5 (6.75)	355.6 (14.00)	152.4 (6.00)
			WYM-1608-2		WYM-1608-2A	304.8 (12.00)	152.4 (6.00)	285.5 (11.25)	133.4 (5.25)

W Series Junction Box Mounting Plate Information

Boxes Available for Raintight, Watertight, or Submersible Applications

Mounting plates are used for mounting equipment up off the back of an enclosure. Steel Plates are all 3.3 mm (0.13") thick hot dip galvanized material. Aluminum plates are 3.3 mm (0.13") thick material up to and including 304.8 x 304.8 mm (12 x 12") size. All larger sizes are constructed of 4.8 mm (0.19") thick aluminum plate.

Select mounting plates based on inside length and width of box. Order as a separate item immediately following the catalog number of the box as follows:

Example: Line 1 **WYS-080804**
Line 2 **WYM-0808-2**

For mounting plates in smaller boxes than listed, use similar catalog number logic. Example: A steel mounting plate for a **WYF-040404** box would be **WYM-0404-1**. Pricing will be based upon a **WYM-0808-1** price.

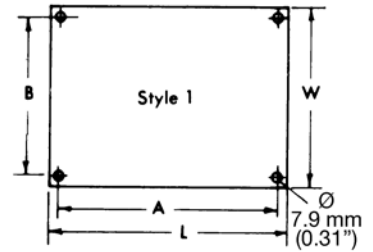

The catalog numbers shown in the table below include the mounting buttons.

Inside Length and Width of Junction Box in mm (in)	Style	Catalog Number – Steel Plates		Catalog Number – Aluminum Plates		Dimension in Millimeters (Inches)			
		For use in Types WYF and WYR Junction Boxes	For use in Types WYS, WYL and WYW Junction Boxes	For use in Types WYF and WYR Junction Boxes	For use in Types WYS, WYL and WYW Junction Boxes	L	W	A	B
406.4 x 304.8 (16 x 12)	1	WYM-1612-1		WYM-1612-1A		374.7 (14.75)	273.1 (10.75)	355.6 (14.00)	254.0 (10.00)
			WYM-1612-2		WYM-1612-2A	355.6 (14.00)	254.0 (10.00)	336.6 (13.25)	235.0 (9.25)
406.4 x 406.4 (16 x 16)	1	WYM-1616-1		WYM-1616-1A		374.7 (14.75)	374.7 (14.75)	355.6 (14.00)	355.6 (14.00)
			WYM-1616-2		WYM-1616-2A	355.6 (14.00)	355.6 (14.00)	336.6 (13.25)	336.6 (13.25)
457.2 x 203.2 (18 x 8)	1	WYM-1808-1		WYM-1808-1A		171.5 (6.75)	171.5 (6.75)	152.4 (6.00)	152.4 (6.00)
			WYM-1808-2		WYM-1808-2A	152.4 (6.00)	152.4 (6.00)	133.4 (5.25)	133.4 (5.25)
457.2 x 254.0 (18 x 10)	1	WYM-1810-1		WYM-1810-1A		171.5 (6.75)	222.3 (8.75)	152.4 (6.00)	203.2 (8.00)
			WYM-1810-2		WYM-1818-2A	152.4 (6.00)	203.2 (8.00)	133.4 (5.25)	184.2 (7.25)
457.2 x 304.8 (18 x 12)	1	WYM-1812-1		WYM-1812-1A		171.5 (6.75)	273.1 (10.75)	152.4 (6.00)	254.0 (10.00)
			WYM-1812-2		WYM-1812-2A	152.4 (6.00)	254.0 (10.00)	133.4 (5.25)	235.0 (9.25)
457.2 x 355.6 (18 x 14)	1	WYM-1814-1		WYM-1814-1A		171.5 (6.75)	323.9 (12.75)	152.4 (6.00)	304.8 (12.00)
			WYM-1814-2		WYM-1814-2A	152.4 (6.00)	304.8 (12.00)	133.4 (5.25)	285.5 (11.25)
457.2 x 406.4 (18 x 16)	1	—		—		—	—	—	—
			WYM-1816-2		WYM-1816-2A	152.4 (6.00)	355.6 (14.00)	133.4 (5.25)	336.6 (13.25)
457.2 x 457.2 (18 x 18)	1	WYM-1818-1		WYM-1818-1A		171.5 (6.75)	171.5 (6.75)	152.4 (6.00)	152.4 (6.00)
			WYM-1818-2		WYM-1818-2A	152.4 (6.00)	152.4 (6.00)	133.4 (5.25)	133.4 (5.25)
508.0 x 254.0 (20 x 10)	1	WYM-2010-1		WYM-2010-1A		222.3 (8.75)	222.3 (8.75)	203.2 (8.00)	203.2 (8.00)
			WYM-2020-2		WYM-2020-2A	203.2 (8.00)	203.2 (8.00)	184.2 (7.25)	184.2 (7.25)

W Series Junction Box Mounting Plate Information

Boxes Available for Raintight, Watertight, or Submersible Applications

Mounting plates are used for mounting equipment up off the back of an enclosure. Steel Plates are all 3.3 mm (0.13") thick hot dip galvanized material. Aluminum plates are 3.3 mm (0.13") thick material up to and including 304.8 x 304.8 mm (12 x 12") size. All larger sizes are constructed of 4.8 mm (0.19") thick aluminum plate.

Select mounting plates based on inside length and width of box. Order as a separate item immediately following the Catalog Number of the box as follows:

Example:
WYS-080804 WYM-0808-2

The catalog numbers shown in the table below include the mounting buttons.

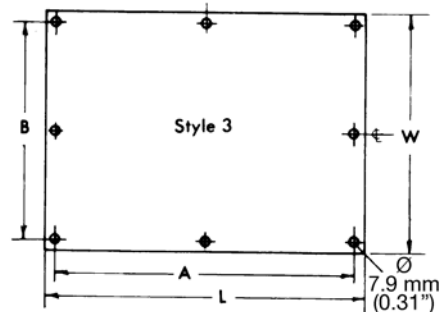
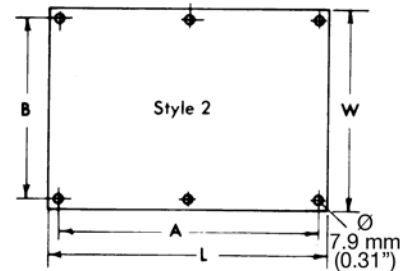

Inside Length and Width of Junction Box in mm (in)	Style	Catalog Number – Steel Plates		Catalog Number – Aluminum Plates		Dimension in Millimeters (Inches)			
		For use in Types WYF and WYR Junction Boxes	For use in Types WYS, WYL and WYW Junction Boxes	For use in Types WYF and WYR Junction Boxes	For use in Types WYS, WYL and WYW Junction Boxes	L	W	A	B
609.6 x 304.8 (24.00 x 12.00)	2	WYM-2412-1	WYM-2412-1	WYM-2412-1A	WYM-2412-1A	552.5 (21.75)	247.7 (9.75)	533.4 (21.00)	228.6 (9.00)
609.6 x 457.2 (24.00 x 18.00)	2	WYM-2418-1	WYM-2418-1	WYM-2418-1A	WYM-2418-1A	552.5 (21.75)	400.1 (15.75)	533.4 (21.00)	381.0 (15.00)
609.6 x 609.6 (24.00 x 24.00)	3	WYM-2424-1	WYM-2424-1	WYM-2424-1A	WYM-2424-1A	552.5 (21.75)	552.5 (21.75)	533.4 (21.00)	533.4 (21.00)
711.2 x 304.8 (28.00 x 12.00)	2	WYM-2812-1	WYM-2812-1	WYM-2812-1A	WYM-2812-1A	654.1 (25.75)	247.7 (9.75)	635.0 (25.00)	228.6 (9.00)
762.0 x 304.8 (30.00 x 12.00)	2	WYM-3012-1	WYM-3012-1	WYM-3012-1A	WYM-3012-1A	704.9 (27.75)	247.7 (9.75)	685.8 (27.00)	228.6 (9.00)
762.0 x 457.2 (30.00 x 18.00)	2	WYM-3018-1	WYM-3018-1	WYM-3018-1A	WYM-3018-1A	704.9 (27.75)	400.1 (15.75)	685.8 (27.00)	381.0 (15.00)
762.0 x 609.6 (30.00 x 24.00)	3	WYM-3024-1	WYM-3024-1	WYM-3024-1A	WYM-3024-1A	704.9 (27.75)	552.5 (21.75)	685.8 (27.00)	533.4 (21.00)
914.4 x 304.8 (36.00 x 12.00)	2	WYM-3612-1	WYM-3612-1	WYM-3612-1A	WYM-3612-1A	857.3 (33.75)	247.7 (9.75)	838.2 (33.00)	228.6 (9.00)
914.4 x 457.2 (36.00 x 18.00)	2	WYM-3618-1	WYM-3618-1	WYM-3618-1A	WYM-3618-1A	857.3 (33.75)	400.1 (15.75)	838.2 (33.00)	381.0 (15.00)
914.4 x 609.6 (36.00 x 24.00)	3	WYM-3624-1	WYM-3624-1	WYM-3624-1A	WYM-3624-1A	857.3 (33.75)	552.5 (21.75)	838.2 (33.00)	533.4 (21.00)
914.4 x 762.0 (36.00 x 30.00)	3	WYM-3630-1	WYM-3630-1	WYM-3630-1A	WYM-3630-1A	857.3 (33.75)	704.9 (27.75)	838.2 (33.00)	685.8 (27.00)
914.4 x 914.4 (36.00 x 36.00)	3	WYM-3636-1	WYM-3636-1	WYM-3636-1A	WYM-3636-1A	857.3 (33.75)	857.3 (33.75)	838.2 (33.00)	838.2 (33.00)

W Series Cast Box Mounting Lug Data

Boxes Available for Raintight, Watertight, or Submersible Applications

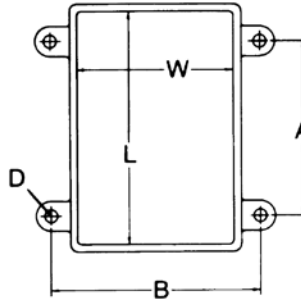

The dimensions listed in these tables are approximate and may vary as much as 6.4 mm (0.25") in any direction.

Types WYS, WYL, WYW, WYU, and WYW

Box Size in mm (in)			Dimension in mm (in)		Bolt Hole Diameter mm (in)
L	x	W	A	B	D
101.6 (4.00)	x	101.6 (4.00)	76.2 (3.00)	136.7 (5.38)	7.9 (0.31)
152.4 (6.00)	x	152.4 (6.00)	101.6 (4.00)	193.8 (7.63)	9.7 (0.38)
203.2 (8.00)	x	203.2 (8.00)	127.0 (5.00)	247.7 (9.75)	9.7 (0.38)
254.0 (10.00)	x	254.0 (10.00)	177.8 (7.00)	298.5 (11.75)	9.7 (0.38)
304.8 (12.00)	x	304.8 (12.00)	203.2 (8.00)	368.3 (14.50)	11.2 (0.44)

Types WYS, WYL, WYW, WYU, and WYW

Box Size in mm (in)			Dimension in mm (in)		Bolt Hole Diameter in mm (in)
L	x	W	A	B	D
406.4 (16.00)	x	304.8 (12.00)	304.8 (12.00)	368.3 (14.50)	11.2 (0.44)
457.2 (18.00)	x	457.2 (18.00)	330.2 (13.00)	530.4 (20.88)	14.2 (0.56)
609.6 (24.00)	x	457.2 (18.00)	482.6 (19.00)	527.1 (20.75)	7.1 (0.28)
609.6 (24.00)	x	609.6 (24.00)	482.6 (19.00)	682.8 (26.88)	14.2 (0.56)
914.4 (36.00)	x	609.6 (24.00)	762.0 (30.00)	682.8 (26.88)	14.2 (0.56)

Types WYF and WYR

Box Size in mm (in)		Dimension in mm (in)		Bolt Hole Diameter in mm (in)
L	x	W	A	D
101.6 (4.00)	x	101.6 (4.00)	76.2 (3.00)	7.9 (0.31)
152.4 (6.00)	x	101.6 (4.00)	127.0 (5.00)	7.9 (0.31)
152.4 (6.00)	x	152.4 (6.00)	101.6 (4.00)	9.7 (0.38)
203.2 (8.00)	x	203.2 (8.00)	127.0 (5.00)	9.7 (0.38)
254.0 (10.00)	x	254.0 (10.00)	177.8 (7.00)	9.7 (0.38)
304.8 (12.00)	x	203.2 (8.00)	203.2 (8.00)	11.2 (0.44)
304.8 (12.00)	x	304.8 (12.00)	203.2 (8.00)	11.2 (0.44)
406.4 (16.00)	x	304.8 (12.00)	304.8 (12.00)	11.2 (0.44)
457.2 (18.00)	x	304.8 (12.00)	330.2 (13.00)	11.2 (0.44)
457.2 (18.00)	x	457.2 (18.00)	330.2 (13.00)	14.2 (0.56)
609.6 (24.00)	x	457.2 (18.00)	482.6 (19.00)	14.2 (0.56)
609.6 (24.00)	x	609.6 (24.00)	482.6 (19.00)	14.2 (0.56)

WYS Type Unflanged Junction or Pull Boxes

W Series: Raintight, Watertight, Dusttight

Cast Iron Box For Surface Mounting.

NEC/CEC:

NEMA/CSA Type 1, 2, 3, 3R, 3S, 4, 5, 12, 12K, 13

Applications

- These boxes are listed by Underwriters Laboratories and Canadian Standards Association as Type 4
- They are suitable for use indoors, outdoors, or where subject to rain, dripping or splashing water or hose-directed water.

Features

- Mounting lugs are standard.
- Type WYS boxes have a post in each corner and allowances must be made for them when conduit entrances are to be located close to a corner.
- Neoprene gasket – between cover and box.
- Suitable for a variety of applications.
- Wide selection of sizes and locations for drilled-and-tapped and slip-hole conduit entrances.

Standard Materials

- Box and cover: cast iron
- Gasket: neoprene
- Screws: stainless steel

Standard Finishes

- Box and cover: hot dip galvanized

Options

- For additional options see *Ordering Information* pages.

NEC/CEC Certifications and Compliances

- UL Standard: UL 514A, UL 50, UL 50E
- UL Listed: E24824
- CSA Standard: C22.2 No. 40
- CSA Certified: 001472
- CSA Certified: Class II, Division 1 and 2, and Class III

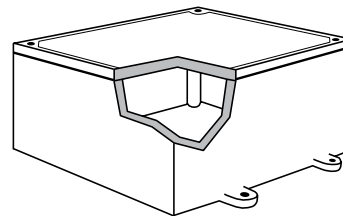

L	x	Inside Dimensions mm (in)		D	Approximate Wall Thickness ① mm (in)	Iron Catalog Number
		W	x			
101.6 (4.00)	x	101.6 (4.00)	x	101.6 (4.00)	6.35 (0.2500)	WYS-040404
152.4 (6.00)	x	152.4 (6.00)	x	101.6 (4.00)	7.94 (0.3125)	WYS-060604
203.2 (8.00)	x	203.2 (8.00)	x	101.6 (4.00)	7.94 (0.3125)	WYS-080804
203.2 (8.00)	x	203.2 (8.00)	x	152.4 (6.00)	7.94 (0.3125)	WYS-080806
254.0 (10.00)	x	254.0 (10.00)	x	101.6 (4.00)	7.94 (0.3125)	WYS-101004
304.8 (12.00)	x	304.8 (12.00)	x	203.2 (8.00)	7.94 (0.3125)	WYS-121208
406.4 (16.00)	x	304.8 (12.00)	x	203.2 (8.00)	7.94 (0.3125)	WYS-161208
457.2 (18.00)	x	304.8 (12.00)	x	254.0 (10.00)	9.53 (0.3750)	WYS-181210
457.2 (18.00)	x	457.2 (18.00)	x	152.4 (6.00)	7.94 (0.3125)	WYS-181806
457.2 (18.00)	x	457.2 (18.00)	x	304.8 (12.00)	11.11 (0.4375)	WYS-181812

① Measured 50.8 mm (2.00") up from back of box.

WYL Type Unflanged Junction or Pull Boxes

W Series: Raintight, Watertight, Dusttight

Cast Iron Box For Surface Mounting.

NEC/CEC:

NEMA/CSA Type 1, 2, 3, 3R, 3S, 4, 5, 12, 12K, 13

Applications

- These boxes are listed by Underwriters Laboratories and Canadian Standards Association as Type 4
- They are suitable for use indoors, outdoors, or where subject to rain, dripping or splashing water or hose-directed water.

Features

- Mounting lugs are standard.
- Type WYL boxes have a post in each corner and allowances must be made for them when conduit entrances are to be located close to a corner.
- Neoprene gasket – between cover and box.
- Wide selection of sizes and locations for drilled-and-tapped and slip-hole conduit entrances.

Standard Materials

- Box and cover: cast iron
- Gasket: neoprene
- Screws: stainless steel

Standard Finishes

- Box and cover: hot dip galvanized

Options

- For additional options see *Ordering Information* pages.

NEC/CEC Certifications and Compliances

- UL Standard: UL 514A, UL 50, UL 50E
- UL Listed: E24824
- CSA Standard: C22.2 No. 40
- CSA Certified: 001472
- CSA Certified: Class II Division 1 and 2, and Class III

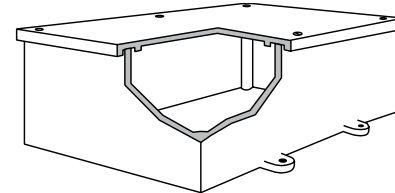

L	Inside Dimensions mm (in)				D	Approximate Wall Thickness ① mm (in)	Iron Catalog Number
	x	W	x				
101.6 (4.00)	x	101.6 (4.00)	x	101.6 (4.00)	6.35 (0.2500)	WYL-040404	
152.4 (6.00)	x	152.4 (6.00)	x	101.6 (4.00)	7.94 (0.3125)	WYL-060604	
203.2 (8.00)	x	203.2 (8.00)	x	101.6 (4.00)	7.94 (0.3125)	WYL-080804	
203.2 (8.00)	x	203.2 (8.00)	x	152.4 (6.00)	7.94 (0.3125)	WYL-080806	
254.0 (10.00)	x	254.0 (10.00)	x	101.6 (4.00)	7.94 (0.3125)	WYL-101004	
304.8 (12.00)	x	304.8 (12.00)	x	203.2 (8.00)	7.94 (0.3125)	WYL-121208	
406.4 (16.00)	x	304.8 (12.00)	x	203.2 (8.00)	7.94 (0.3125)	WYL-161208	
457.2 (18.00)	x	304.8 (12.00)	x	254.0 (10.00)	9.53 (0.3750)	WYL-181210	
457.2 (18.00)	x	457.2 (18.00)	x	152.4 (6.00)	7.94 (0.3125)	WYL-181806	
457.2 (18.00)	x	457.2 (18.00)	x	304.8 (12.00)	11.11 (0.4375)	WYL-181812	
609.6 (24.00)	x	609.6 (24.00)	x	304.8 (12.00)	11.11 (0.4375)	WYL-242412	
914.4 (36.00)	x	609.6 (24.00)	x	304.8 (12.00)	11.11 (0.4375)	WYL-362412	

① Measured 50.8 mm (2.00") up from back of box.

WYW Type Hinged Cover Boxes

W Series: Watertight, Raintight, Dust Tight

Cast Iron Box for Surface Mounting.

NEC/CEC:

NEMA/CSA Type 1, 2, 3, 3R, 3S, 4, 5, 12, 12K, 13

Applications

- These boxes are listed by Underwriters Laboratories and Canadian Standards Association as Type 4
- They are suitable for use indoors, outdoors, or where subject to rain, dripping or splashing water or hose-directed water.
- These hinged cover boxes make ideal enclosures where equipment within the box has to be inspected frequently or easy access is required.
- The hinges are adjusted at the factory for proper gasket pressure, but can be readjusted in the field.

Features

- Mounting lugs are standard.
- Hinges are always located on the long side of the box and unless otherwise specified on the right side.
- Hinged cover for easy access to wiring for inspection and maintenance.
- Three-rivet anchoring of hinges and bolt/wing nut fasteners.
- Type WYW Boxes have a post in each corner and allowances must be made for them when conduit entrances are to be located close to a corner.
- Neoprene gasket – between cover and box.
- Wide selection of sizes and locations for drilled-and-tapped and slip-hole conduit entrances.

Standard Materials

- Box and cover: cast iron
- Gasket: neoprene
- Screws: stainless steel

Standard Finishes

- Box and cover: hot dip galvanized

Options

- For additional options see *Ordering Information* pages.

NEC/CEC Certifications and Compliances

- UL Standard: UL 514A, UL 50, UL 50E
- UL Listed: E24824
- CSA Standard: C22.2 No. 40
- CSA Certified: 001472
- CSA Certified: Class II Division 1 and 2, and Class III

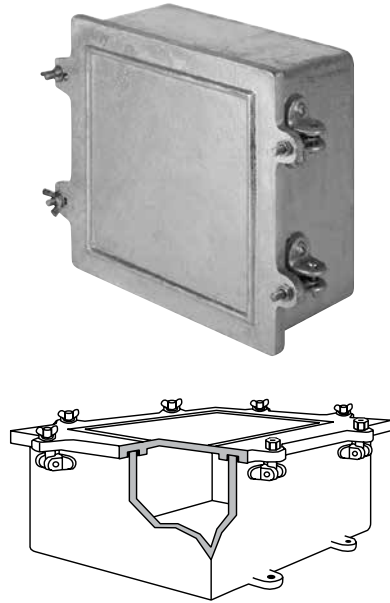

Inside Dimensions mm (in)					Approximate Wall Thickness ① mm (in)	Iron Catalog Number
L	x	W	x	D		
203.2 (8.00)	x	203.2 (8.00)	x	152.4 (6.00)	7.94 (0.3125)	WYW-080806
304.8 (12.00)	x	304.8 (12.00)	x	203.2 (8.00)	7.94 (0.3125)	WYW-121208

① Measured 50.8 mm (2.00") up from back of box.

WYF Type Flat Flanged Boxes

W Series: Submersible ①, Watertight, Raintight, Dust Tight

Cast Iron Box for Surface Mounting.

NEC/CEC:

NEMA/CSA Type 1, 2, 3, 3R, 3S, 4, 5, 6, 6P, 12, 12K, 13

Applications

- These boxes are listed by Underwriters Laboratories and Canadian Standards Association as Type 4.
- Submersible Type 6 – see options below.
- They are suitable for use indoors, outdoors, or where subject to rain, dripping or splashing water or hose-directed water.

Features

- Mounting lugs are standard.
- Wide flange provides greater contact between gasket cover and box.
- Neoprene gasket – between cover and box.

Standard Materials

- Box and cover: cast iron
- Gasket: neoprene
- Screws: stainless steel

Standard Finishes

- Box and cover: hot dip galvanized

Options

- For additional options see *Ordering Information* pages.
- Submersible Applications ①
 - These boxes can be tested to withstand occasional submersion under a 1.83 meter (6 foot) head of water for 30 minutes (NEMA 6 requirements). Add suffix **-SUB6** to standard catalog number.
 - These boxes can be tested to withstand Prolonged submersion under a 1.83 meter (6 foot) head of water for 24 hours (NEMA 6P requirements). Add suffix **-SUB6P** to standard catalog number.
 - These boxes can be tested to withstand submersion up to a 6.10 meter (20 foot) head of water. Add suffix **-SUB__** to standard catalog number, filling in the blank space with the number of **feet** from 7 up to 20, followed by **-P** if prolonged submersion is required.
- All WYF-SUB enclosures are subject to a price addition on application and must have:
 1. Mounting lugs
 2. Bossed, drilled, and tapped conduit entrances (ABDT series)

NEC/CEC Certifications and Compliances

- UL Standard: UL 514A, UL 50, UL 50E
- UL Listed: E-24824
- CSA Standard: C22.2 No. 40
- CSA Certified: 001472
- CSA Certified: Class II Division 1 and 2, and Class III

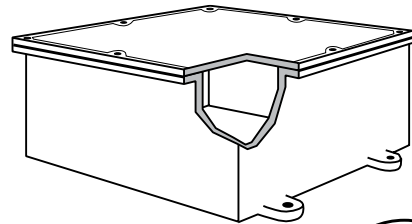

The ridge on the underside of the cover assures a good seal.

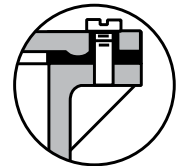

① Intended for indoor or outdoor use primarily to provide a degree of protection against hose-directed water and the entry of water during submersion at a limited depth; and to be undamaged by the formation of ice on the enclosure.

WYF Type Flat Flanged Boxes

W Series: Submersible ①, Watertight, Raintight, Dust Tight

Cast Iron or Aluminum Box for Surface Mounting.

NEC/CEC:

NEMA/CSA Type 1, 2, 3, 3R, 3S, 4, 5, 6, 6P, 12, 12K, 13

Enclosures and Junction Boxes

ENCLOSURES AND JUNCTION BOXES: ORDINARY LOCATION JUNCTION BOXES

Inside Dimensions mm (in)				D	Approximate Wall Thickness ② mm (in)	Iron Catalog Number
L	x	W	x			
101.6 (4.00)	x	101.6 (4.00)	x	101.6 (4.00)	6.35 (0.2500)	WYF-040404
152.4 (6.00)	x	101.6 (4.00)	x	101.6 (4.00)	7.94 (0.3125)	WYF-060404
152.4 (6.00)	x	152.4 (6.00)	x	101.6 (4.00)	7.94 (0.3125)	WYF-060604
203.2 (8.00)	x	152.4 (6.00)	x	152.4 (6.00)	7.94 (0.3125)	WYF-080806
254.0 (10.00)	x	254.0 (10.00)	x	101.6 (4.00)	7.94 (0.3125)	WYF-101004
304.8 (12.00)	x	203.2 (8.00)	x	101.6 (4.00)	6.35 (0.2500)	WYF-120804
304.8 (12.00)	x	304.8 (12.00)	x	152.4 (6.00)	7.94 (0.3125)	WYF-121206
406.4 (16.00)	x	304.8 (12.00)	x	203.2 (8.00)	7.94 (0.3125)	WYF-161208
457.2 (18.00)	x	304.8 (12.00)	x	254.0 (10.00)	7.94 (0.3125)	WYF-181210
457.2 (18.00)		457.2 (18.00)		254.0 (10.00)	7.94 (0.3125)	WYF-181810
609.6 (24.00)	x	457.2 (18.00)	x	304.8 (12.00)	8.73 (0.3438)	WYF-241812
609.6 (24.00)	x	609.6 (24.00)	x	304.8 (12.00)	9.53 (0.3750)	WYF-242412

Inside Dimensions mm (in)				D	Approximate Wall Thickness ② mm (in)	Iron Catalog Number
L	x	W	x			
101.6 (4.00)	x	101.6 (4.00)	x	101.6 (4.00)	6.35 (0.2500)	WYF-040404-SUB6
152.4 (6.00)	x	101.6 (4.00)	x	101.6 (4.00)	7.94 (0.3125)	WYF-060404-SUB6
152.4 (6.00)	x	152.4 (6.00)	x	101.6 (4.00)	7.94 (0.3125)	WYF-060604-SUB6
203.2 (8.00)	x	152.4 (6.00)	x	152.4 (6.00)	7.94 (0.3125)	WYF-080806-SUB6
254.0 (10.00)	x	254.0 (10.00)	x	101.6 (4.00)	7.94 (0.3125)	WYF-101004-SUB6
304.8 (12.00)	x	203.2 (8.00)	x	101.6 (4.00)	6.35 (0.2500)	WYF-120804-SUB6
304.8 (12.00)	x	304.8 (12.00)	x	152.4 (6.00)	7.94 (0.3125)	WYF-121206-SUB6
406.4 (16.00)	x	304.8 (12.00)	x	203.2 (8.00)	7.94 (0.3125)	WYF-161208-SUB6
457.2 (18.00)	x	304.8 (12.00)	x	254.0 (10.00)	7.94 (0.3125)	WYF-181210-SUB6
457.2 (18.00)		457.2 (18.00)		254.0 (10.00)	7.94 (0.3125)	WYF-181810-SUB6
609.6 (24.00)	x	457.2 (18.00)	x	304.8 (12.00)	8.73 (0.3438)	WYF-241812-SUB6
609.6 (24.00)	x	609.6 (24.00)	x	304.8 (12.00)	9.53 (0.3750)	WYF-242412-SUB6

Inside Dimensions mm (in)				D	Approximate Wall Thickness ② mm (in)	Iron Catalog Number
L	x	W	x			
101.6 (4.00)	x	101.6 (4.00)	x	101.6 (4.00)	6.35 (0.2500)	WYF-040404-SUB6P
152.4 (6.00)	x	101.6 (4.00)	x	101.6 (4.00)	7.94 (0.3125)	WYF-060404-SUB6P
152.4 (6.00)	x	152.4 (6.00)	x	101.6 (4.00)	7.94 (0.3125)	WYF-060604-SUB6P
203.2 (8.00)	x	152.4 (6.00)	x	152.4 (6.00)	7.94 (0.3125)	WYF-080806-SUB6P
254.0 (10.00)	x	254.0 (10.00)	x	101.6 (4.00)	7.94 (0.3125)	WYF-101004-SUB6P
304.8 (12.00)	x	203.2 (8.00)	x	101.6 (4.00)	6.35 (0.2500)	WYF-120804-SUB6P
304.8 (12.00)	x	304.8 (12.00)	x	152.4 (6.00)	7.94 (0.3125)	WYF-121206-SUB6P
406.4 (16.00)	x	304.8 (12.00)	x	203.2 (8.00)	7.94 (0.3125)	WYF-161208-SUB6P
457.2 (18.00)	x	304.8 (12.00)	x	254.0 (10.00)	7.94 (0.3125)	WYF-181210-SUB6P
457.2 (18.00)		457.2 (18.00)		254.0 (10.00)	7.94 (0.3125)	WYF-181810-SUB6P
609.6 (24.00)	x	457.2 (18.00)	x	304.8 (12.00)	8.73 (0.3438)	WYF-241812-SUB6P
609.6 (24.00)	x	609.6 (24.00)	x	304.8 (12.00)	9.53 (0.3750)	WYF-242412-SUB6P

① Intended for indoor or outdoor use primarily to provide a degree of protection against hose-directed water and the entry of water during submersion at a limited depth; and to be undamaged by the formation of ice on the enclosure.

② Measured 50.8 mm (2.00") up from back of box.

WYR Outside Flanged Recessed Cover Boxes

W Series: Watertight, Raintight, Dust Tight

Cast Iron Box for Flush Mounting.

NEC/CEC:

NEMA/CSA Type 1, 2, 3, 3R, 3S, 4, 5, 12, 12K, 13

Applications

- These boxes are listed by Underwriters Laboratories and Canadian Standards Association as Type 4.
- They are suitable for use indoors, or where subject to rain, dripping or splashing water or hose-directed water.
- This type of box is designed especially for flush mounting in masonry in walls or floors or can be used for surface mounting using optional mounting lugs.

Features

- Neoprene gasket – between cover and box.
- Wide box flange permits greater contact between gasket and box.
- Wide selection of sizes and locations for drilled-and-tapped and slip-hole conduit entrances.

Standard Materials

- Box and cover: cast iron
- Gasket: neoprene
- Screws: stainless steel

Standard Finishes

- Box and cover: hot dip galvanized

Options

- Checkered steel plate covers suitable for pedestrian traffic add suffix **-CS**.
- Checkered steel covers suitable for vehicular traffic (H-25 loading) add suffix **-CSV**.
- For additional options see *Ordering Information* pages.

NEC/CEC Certifications and Compliances

- UL Standard: UL 514A, UL 50, UL 50E
- UL Listed: E24824
- CSA Standard: C22.2 No. 40
- CSA Certified: 001472
- CSA Certified: Class II Division 1 and 2, and Class III

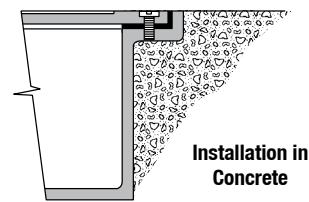

L	Inside Dimensions mm (in)				D	Approximate Wall Thickness ① mm (in)	Iron Catalog Number
	x	W	x				
101.6 (4.00)	x	101.6 (4.00)	x	101.6 (4.00)	6.35 (0.2500)	WYR-040404	
152.4 (6.00)	x	152.4 (6.00)	x	101.6 (4.00)	7.94 (0.3125)	WYR-060604	
203.2 (8.00)	x	203.2 (8.00)	x	152.4 (6.00)	7.94 (0.3125)	WYR-080806	
254.0 (10.00)	x	254.0 (10.00)	x	152.4 (6.00)	7.94 (0.3125)	WYR-101006	
304.8 (12.00)	x	304.8 (12.00)	x	203.2 (8.00)	7.94 (0.3125)	WYR-121208	
355.6 (14.00)	x	203.2 (8.00)	x	152.4 (6.00)	7.94 (0.3125)	WYR-140806	
406.4 (16.00)	x	304.8 (12.00)	x	203.2 (8.00)	7.94 (0.3125)	WYR-161208	
457.2 (18.00)	x	304.8 (12.00)	x	152.4 (6.00)	7.94 (0.3125)	WYR-181206	
457.2 (18.00)	x	304.8 (12.00)	x	254.0 (10.00)	7.94 (0.3125)	WYR-181210	
457.2 (18.00)	x	457.2 (18.00)	x	304.8 (12.00)	7.94 (0.3125)	WYR-181812	
609.6 (24.00)	x	609.6 (24.00)	x	304.8 (12.00)	9.53 (0.3750)	WYR-242412	

① Measured 50.8 mm (2.00") up from back of box.

WYU Type Inside Flanged Recessed Cover Boxes

W Series: Raintight, Dust Tight

Cast Iron Box for Flush Mounting.

NEC/CEC:

NEMA/CSA Type 1, 2, 3, 3R, 3S, 5, 12, 12K, 13

Enclosures and Junction Boxes

ENCLOSURES AND JUNCTION BOXES: ORDINARY LOCATION JUNCTION BOXES

Applications

- These boxes are listed by Underwriters Laboratories and Canadian Standards Association as Type 3R.
- They are suitable for use indoors, outdoors, or where subject to rain, dripping or splashing water.
- Recessed cover boxes designed for flush mounting in masonry.
- They are furnished with a plain cover as shown but can be supplied with checkered steel plate covers suitable for foot traffic (see options).

Features

- Neoprene gasket – between cover and box.
- Wide selection of sizes and locations for drilled-and-tapped and slip-hole conduit entrances.

Standard Materials

- Box and cover: cast iron
- Gasket: neoprene
- Screws: stainless steel

Standard Finishes

- Box and cover: hot dip galvanized

Options

- Checkered steel plate covers suitable for pedestrian traffic, add suffix **-CS**.
- See optional hinges below.
- For additional options see *Ordering Information* pages.

NEC/CEC Certifications and Compliances

- UL Standard: UL 514A, UL 50, UL 50E
- UL Listed: E24824
- CSA Standard: C22.2 No. 40
- CSA Certified: 001472
- CSA Certified: Class II Division 1 and 2, and Class III



Installation in Concrete

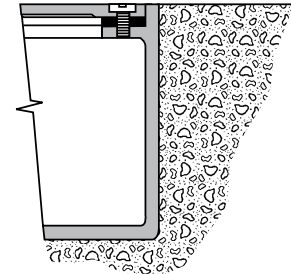

L	Inside Dimensions Millimeters (Inches)				D	Approximate Wall Thickness ① mm (in)	Iron Catalog Number
	x	W	x	x			
101.6 (4.00)	x	101.6 (4.00)	x	101.6 (4.00)	6.35 (0.2500)	WYU-040404	
152.4 (6.00)	x	152.4 (6.00)	x	152.4 (6.00)	7.94 (0.3125)	WYU-060606	
203.2 (8.00)	x	203.2 (8.00)	x	152.4 (6.00)	7.94 (0.3125)	WYU-080806	
304.8 (12.00)	x	304.8 (12.00)	x	152.4 (6.00)	7.94 (0.3125)	WYU-121206	

Optional Hinges (Stainless Steel, Butt Type)

Hinges Per Set	Box Size	Catalog Number
2	Up to 304.8 x 304.8 mm (12" x 12")	AHNG-22SS

① Measured 50.8 mm (2.00") up from back of box.

WYT Type Checkered Cover Sidewalk Boxes

W Series: Weatherproof

Cast Iron Box for Flush Mounting.

Applications

- These boxes are specially designed to be mounted in sidewalks and other flat concrete surfaces. Their checkered covers are made to withstand pedestrian traffic.
- The flanges and covers are interchangeable to permit replacement without disturbing the box or conduit system.
- Heavy checkered steel covers can be furnished which will accommodate vehicular traffic (see *Options*).

Features

- Type WYT boxes have a post in each corner and allowances must be made for them, when conduit entrances are to be located close to a corner.
- Cross ribbed, heavy duty cover with pry bar slots.
- Checkered cover provides non-slip surface.
- Neoprene gasket – between cover and box.
- Wide selection of locations for drilled and tapped and slip hole conduit entrances.

Standard Materials

- Box and cover: cast iron
- Gasket: neoprene
- Screws: stainless steel

Standard Finishes

- Box and cover: hot dip galvanized

Options

- Checkered steel covers suitable for vehicular traffic H-25 loading, add suffix **-CSV**.
- Engraved lettering on cover per specifications.
- For additional options see *Ordering Information* pages.

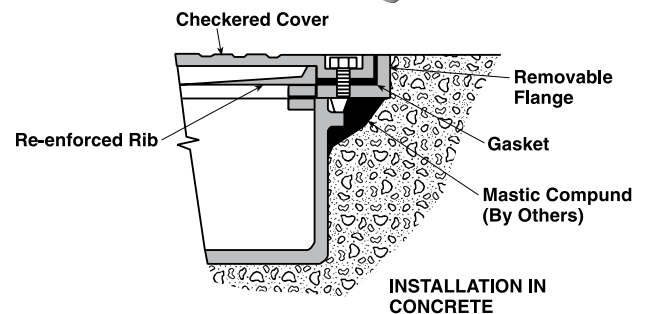

L	Inside Dimensions mm (in)				D	Approximate Wall Thickness ① mm (in)	Iron Catalog Number
	x	W	x				
152.4 (6.00)	x	152.4 (6.00)	x	101.6 (4.00)	7.94 (0.3125)	WYT-060604	
203.2 (8.00)	x	152.4 (6.00)	x	101.6 (4.00)	7.94 (0.3125)	WYT-080604	
203.2 (8.00)	x	203.2 (8.00)	x	152.4 (6.00)	7.94 (0.3125)	WYT-080806	
304.8 (12.00)	x	203.2 (8.00)	x	203.2 (8.00)	7.94 (0.3125)	WYT-120808	
304.8 (12.00)	x	304.8 (12.00)	x	152.4 (6.00)	7.94 (0.3125)	WYT-121206	
609.6 (24.00)	x	304.8 (12.00)	x	203.2 (8.00)	7.94 (0.3125)	WYT-241208	

① Measured 50.8 mm (2.00") up from back of box.

WY58E Type Checkered Cover Sidewalk Topping Box

W Series: Weatherproof

Cast Iron Box for Flush Mounting.

Applications

- These open-bottom boxes are designed to top off an underlying concrete pull box.

Features

- The construction details of the cover and flange are the same as those of a Type WYT.
- Frame and cover are interchangeable and may be replaced if damaged without disturbing the rest of the system.
- Checkered cover provides non-slip surface for pedestrian traffic.
- Cross-ribbed checkered cover with pry bar slots.
- Cover secures to frame with recessed stainless steel hex head cap screws.
- Neoprene gasket – between cover and box.
- Wide selection of locations for drilled and tapped and slip hole conduit entrances.

Standard Materials

- Box, flange and cover: cast iron
- Neoprene gasket
- Screws: stainless steel

Standard Finishes

- Box and cover: hot dip galvanized

Options

- Engraved lettering on cover per specifications.

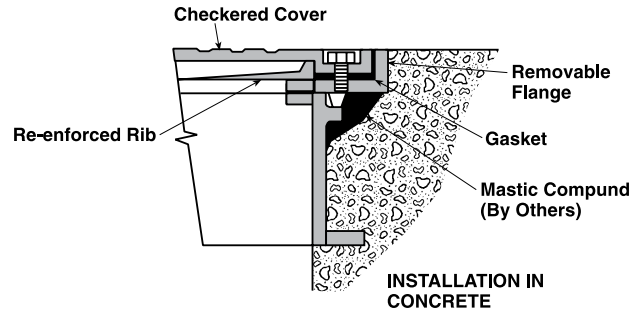

L	Inside Dimensions mm (in)			D	Approximate Wall Thickness ① mm (in)	Iron Catalog Number
	x	W	x			
304.8 (12.00)	x	304.8 (12.00)	x	127.0 (5.00)	9.53 (0.3750)	WY58E-1212
609.6 (24.00)	x	609.6 (24.00)	x	127.0 (5.00)	9.53 (0.3750)	WY58E-2424

① Measured 50.8 mm (2.00") up from back of box.