

84014-40



UPC Code: 07847743030

Country of Origin: Please Contact Customer Service

Wallplates

Brand Features

Familiar and functional, Leviton Traditional Wallplates are designed for use with Traditional Leviton devices. They represent styles and form factors that have stood the test of time. Their clean lines work in virtually any location, whether in new or retrofit construction, and they install quickly and easily. Leviton offers Traditional Wallplates in a vast array of colors and configurations.

Item Description

1-Gang No Device Blank Wallplate, Standard Size, 302 Stainless Steel, Box Mount, - Stainless Steel

Technical Information

Product Features

Type: Standard Size

Gang: 1

Device: No

Material: 302 Stainless Steel

Color: Brushed Stainless Steel

Color: Stainless Steel

Mount: Box

Standards and Certifications: UL/CSA

Warranty: 10-Year Limited

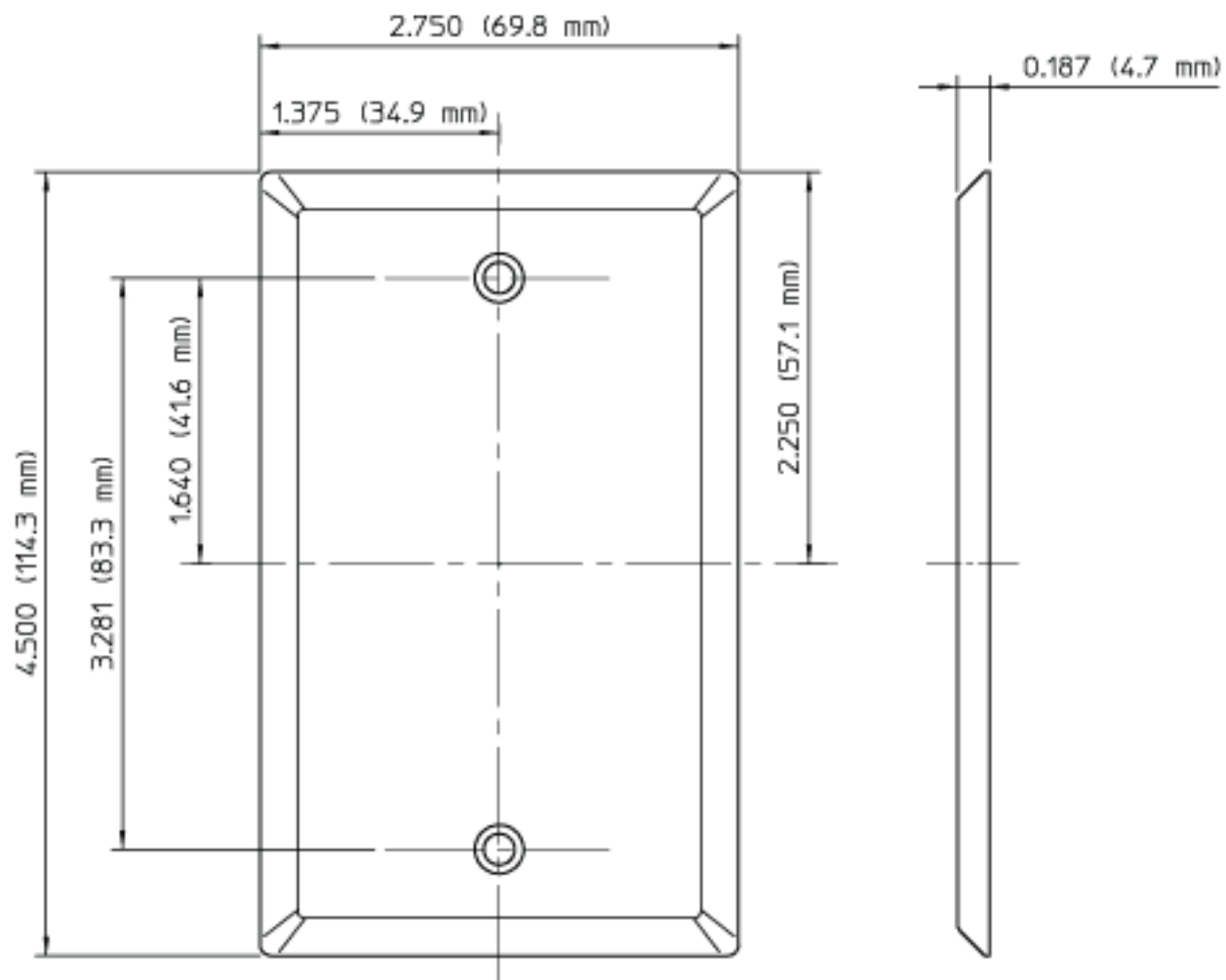

SPECIFICATION SUBMITTAL

JOB NAME:	CATALOG NUMBERS:	
<input type="text"/>	<input type="text"/>	<input type="text"/>
JOB NUMBER:	<input type="text"/>	<input type="text"/>

Leviton Manufacturing Co., Inc.

201 North Service Road, Melville, NY 11747

Telephone: 1-800-323-8920 · FAX: 1-800-832-9538 · Tech Line (8:30AM-7:30PM E.S.T. Monday-Friday): 1-800-824-3005

Leviton Manufacturing of Canada, Ltd.

165 Hymus Boulevard, Pointe Claire, Quebec H9R 1E9 · Telephone: 1-800-469-7890 ·

FAX: 1-800-824-3005 · www.leviton.com/canada

Leviton S. de R.L. de C.V.

Lago Tana 43, Mexico DF, Mexico CP 11290 · Tel.: (+52)55-5082-1040 · FAX: (+52)5386-1797 · www.leviton.com.mx

Visit our Website at: www.leviton.com

© 2012-2013 Leviton Manufacturing Co., Inc. All rights reserved. Subject to change without notice.

Leviton has a global presence.

If you would like to know where your local Leviton office is located please go to: www.leviton.com/international/contacts/

