



Fits decorator wall plates with only 1/2" protrusion. 120 volts. Gangable. Full 180° view covers 1000 sq. ft Works with electronic ballasts. Can be wired in parallel. LED indicator, wallplate included. Can also be used as a ceiling sensor. Must have hot and wires in box.

Color: White

Weight: 0.3 lbs

Project:	Type:
Prepared By:	Date:

Technical Specifications

Listings

UL Listing:

Indoor applications Smart Box & Tuff Dome Wet locations.

Construction

Compatibility:

Compatible with most electronic ballasts. Not compatible with instant start ballasts. Can be wired in parallel.

Electrical

Maximum Energy Savings:

Light only when you need it. No ON switch so lights are never left on by mistake.

Incandescent & Fluorescent Watts Switched:

1200 watts @ 277 volts.

Ratings:

4.3 amps.

Power Consumption:

Negligible

Manual Switch:

On - Manual / Off - Auto.

Wiring:

Hot & common.

Optical

Coverage Area:

1000sf

Sensor Characteristics

Time Delay:

8 seconds to 15 minutes.

Ambient Light Sensing:

n/a

Detection:

180° view covers 1000 sq. feet.

Other

Adjustments:

Time

Dimensions

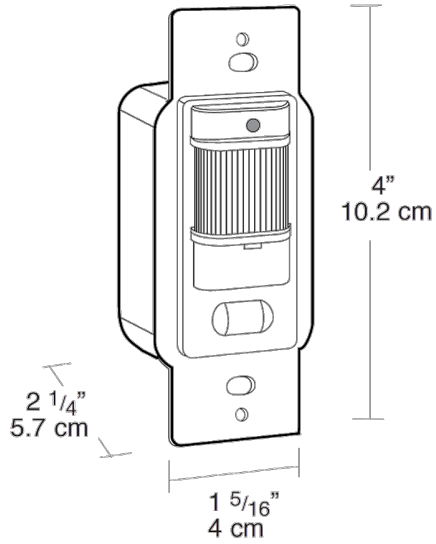

Features

- Full 180° view
- LED detection indicator
- Tough, vandal resistant lens
- Fits decorator wall plates
- Control panel cover only removable with wall plate to prevent tampering
- Manual off/auto switch
- Vandal proof sensor for schools, gyms and high abuse areas