

## Twist-Lock® Devices

### 50A, 250V DC, 600V AC, 3 Pole, 4 Wire Grounding

#### Insulgrip® Connector

# HUBBELL

#### Features

- Box terminal with hex socket threaded slug, permits high clamping pressure on conductors without damaging strands
- Heavy duty two-piece external cord clamp provides maximum strain relief
- Box terminal with hex socket threaded slug, permits high clamping pressure on conductors without damaging strands
- Thermoplastic polyester interior provides heat resistance and impact strength
- Oversized contacts minimize operating temperature



#### Ordering Information

Description	Cord Diameter	UPC	Catalog Number
Nylon cover, thermoplastic polyester interior	.830"-1.250" (21.08-31.75)	783585237848	<b>HBL7764C</b>

#### Listings

Listed to UL 498  
Certified to CSA C22.2 No.42

#### Specifications

Housing	Nylon
Terminal Retainer	Thermoplastic polyester
Contacts	Brass
Terminal Screws	Stainless Steel
Cord Grip	Polyester

#### Performance

Electrical	
Current Interrupting	Certified for current interrupting at full rated current
Dielectric Voltage	Withstands 2,000V minimum

Mechanical	
Terminal Accommodation	#8 AWG - #4 AWG stranded copper wire only

Environmental	
Flammability	HB or better
Operating Temperatures	Maximum continuous 75°C; minimum -40°C (w/o impact)

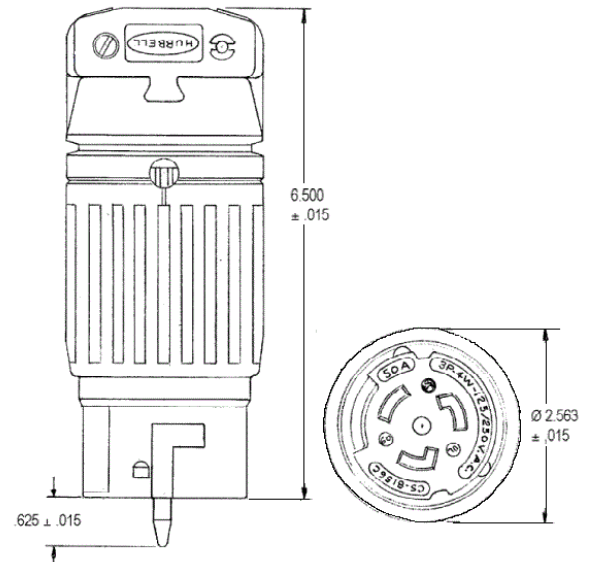

#### Accessories

Plug	<b>HBL7765C</b>
Weatherproof Boot	<b>HBL7717C</b>
Flanged Inlet	<b>HBL7958</b>
Weatherproof Boot	<b>HBL7716C</b>

#### Online Resources

Customer Use Drawing  
eCatalog  
Installation Instructions

Dimensions in Inches (mm)

Hubbell Wiring Device-Kellems • Hubbell Incorporated (Delaware) • 40 Waterview Drive • Shelton, CT 06484

Phone (800) 288-6000 • Fax (800) 255-1031 • Specifications subject to change without notice.

