

# Wall studs

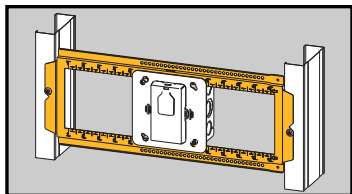

## Open Box Mounting Bracket



- Open box support allows for adjustability of box position between studs.
- Supports most US and Canadian boxes and/or plaster rings 4" SQ., 4<sup>11</sup>/<sub>16</sub>" SQ., 5" SQ., and multi-gang boxes.
- Fits up to 1 1/2" wide studs 16" to 24" on center.
- Compatible with Rapid Ring™ & adjustable plaster rings.
- Field cut to adjust to non-standard stud spacings.
- Stamped markings at 1/4", 1/2", and 1" increments to allow the installer to easily locate the desired box position.
- Contact factory for pre-fab box assemblies.
- Finish: Pre-Galvanized.
- Patent Pending.

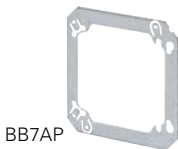

UPC/Part Number	Catalog Number	Description	Box Qty.
79903856401	<b>BB7-16</b>	16" Stud Spacing	25
79903856402	<b>BB7-24</b>	24" Stud Spacing	25
79903859494	<b>BB7AP</b>	Alignment Plate	100

Can be cut on a mark to make shorter length brackets.

Can be used with BBFS-18 (floor stand) See pages 29 & 30.



Read safety/installation instruction sheets in packages before use. These products are designed for positioning only. No load rating.

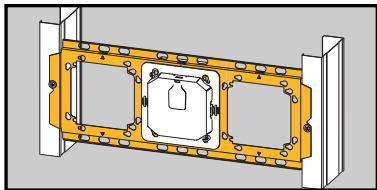

## Box Mounting Bracket



- Increased strength and rigidity to help withstand the stress of drywall installation.
- Supports most US & Canadian boxes and plaster rings 4" SQ. and 4<sup>11/16</sup>" SQ.
- Compatible with 1-gang and 2-gang Rapid Ring™ and adjustable plaster rings.
- Contact factory for pre-fab box assemblies.
- Finish: Pre-Galvanized.
- Patent Pending.



BB8-16

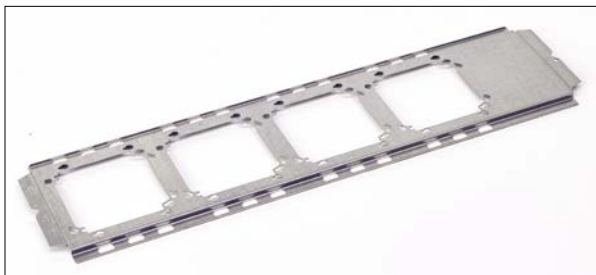

BB8-24

UPC/Part Number	Catalog Number	Description	Box Qty.
78101102898	<b>BB8-16</b>	16" Stud Spacing	25
78101102900	<b>BB8-24</b>	24" Stud Spacing	25

*Read safety/installation instruction sheets in packages before use.  
These products are designed for positioning only. No load rating.*

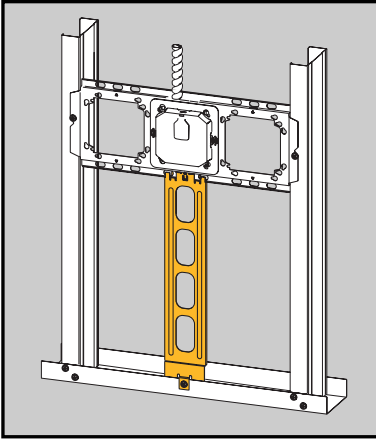

- Bracket accessories require no tools to install.
- BBFS-18 floor stand ensures consistent box height and eliminates need to measure for proper install height.
- Can be used with BB7 (page 27) and BB8 (page 28) brackets.
- Finish: Pre-Galvanized.

## Box Mounting Bracket Accessories

BBFS-18 Installed (Can be used with BB7 or BB8 brackets)

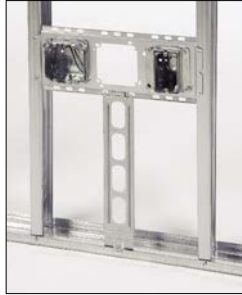
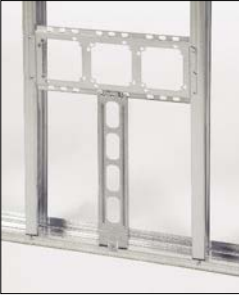

BBFS-18

UPC/Part Number	Catalog Number	Description	Box Qty.
79903851597	<b>BBFS-18</b>	Floor Stand	25

*Read safety/installation instruction sheets in packages before use. These products are designed for positioning only. No load rating.*

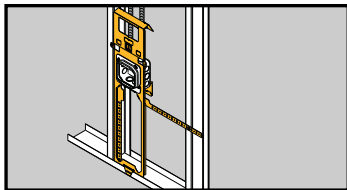

## Floor-Mount Box Support



BBF15



BBF18



BBFC



BBF24



BBFxxC



- New BBF floorstand provides the most rigid support in the industry.
- Far-side support accommodates 6", 5½", 3⅝", and 2½" stud depths.
- Fold-out tab built-in to attach floor stand to stud if desired.
- Integral "wings" provide rigid support when floorstand is mounted between studs.
- Optional cable containment clip securely attaches to floorstand without hardware.
- Patented Marty Mouse™ ears enable boxes to be secured in place with or without the plaster rings.
- Finish: Pre-Galvanized.
- Contact factory for pre-fab box assemblies.

UPC/Part Number	Catalog Number	Box Center Height	Box Qty.
78205152944	<b>BBF15</b>	15" Floorstand	25
78205152945	<b>BBF18</b>	18" Floorstand	25
78205152946	<b>BBF24</b>	24" Floorstand	25
78205152947	<b>BBFC</b>	18" Floorstand	25
78205152948	<b>BBF15C</b>	15" Floorstand with Cable Clip	25
78205152949	<b>BBF18C</b>	18" Floorstand with Cable Clip	25
78205152950	<b>BBF24C</b>	24" Floorstand with Cable Clip	25

Patent #5595362  
Patent #7956285 B2

*Read safety/installation instruction sheets in packages before use.  
These products are designed for positioning only. No load rating.*

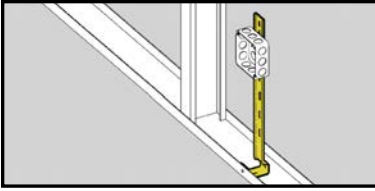

## Floor Mounted Box Support

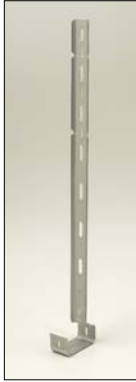

- See **BBF Series (page 30)** for a better solution.
- Provides support for electrical box from floor track or concrete forms.
- 18" length with break-away feature for 12" or 16" box mounting.
- Finish: Pre-Galvanized.

UPC/Part Number	Catalog Number	Description	Box Qty.
78101103623	<b>BB-18</b>	Floor Mounted Box Support	50

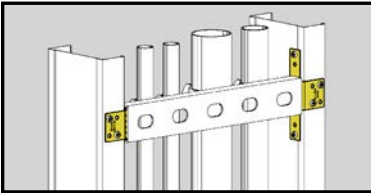

## Strut Mounting Brackets



- Attaches  $1\frac{3}{16}$ " strut,  $1\frac{1}{2}$ " lathers channel,  $\frac{1}{2}$ " EMT or  $\frac{3}{4}$ " EMT to metal studs.
- Provides support for vertical runs of conduit.
- Finish: Pre-Galvanized.

UPC/Part Number	Catalog Number	Description	Box Qty.
78101101658	<b>BMB1</b>	Strut Mounting Bracket	25 pr.

*Read safety/installation instruction sheets in packages before use. These products are designed for positioning only. No load rating.*