

80528-W

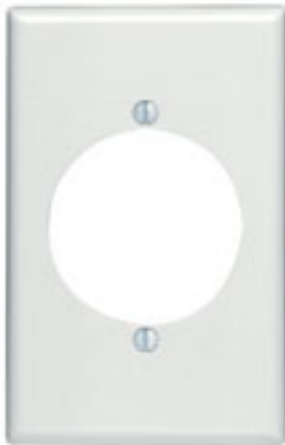

UPC Code: 07847783678

Country of Origin: United States - **Eligible for ARRA funded projects*



**May include one or more globally sourced components.*



Wallplates

Brand Features

Familiar and functional, Leviton Traditional Wallplates are designed for use with Traditional Leviton devices. They represent styles and form factors that have stood the test of time. Their clean lines work in virtually any location, whether in new or retrofit construction, and they install quickly and easily. Leviton offers Traditional Wallplates in a vast array of colors and configurations.

Item Description

1-Gang Flush Mount 2.15 Inch Dia. Device Receptacle Wallplate, Midway Size, Thermoset, Device Mount - White

Technical Information

Product Features

Type: Midway Size

Gang: 1

Material: Thermoset

Color: White

Mount: Device

Standards and Certifications: UL/CSA

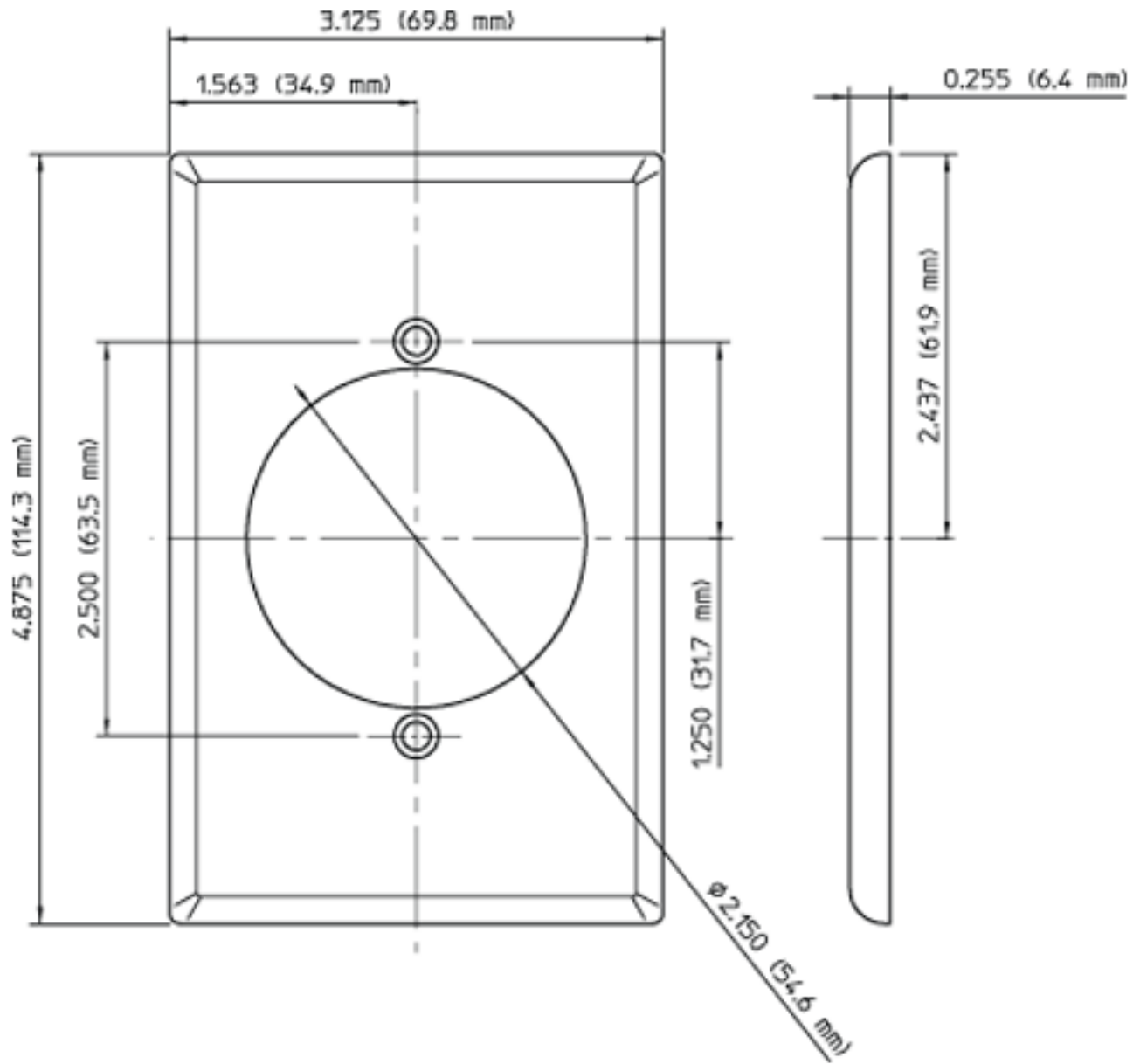

SPECIFICATION SUBMITTAL

JOB NAME:	CATALOG NUMBERS:	
<input type="text"/>	<input type="text"/>	<input type="text"/>
JOB NUMBER:	<input type="text"/>	<input type="text"/>

Leviton Manufacturing Co., Inc.

201 North Service Road, Melville, NY 11747

Telephone: 1-800-323-8920 · FAX: 1-800-832-9538 · Tech Line (8:30AM-7:30PM E.S.T. Monday-Friday): 1-800-824-3005

Leviton Manufacturing of Canada, Ltd.

165 Hymus Boulevard, Pointe Claire, Quebec H9R 1E9 · Telephone: 1-800-469-7890 ·

FAX: 1-800-824-3005 · www.leviton.com/canada

Leviton S. de R.L. de C.V.

Lago Tana 43, Mexico DF, Mexico CP 11290 · Tel.: (+52)55-5082-1040 · FAX: (+52)5386-1797 · www.leviton.com.mx

Visit our Website at: www.leviton.com

© 2012-2013 Leviton Manufacturing Co., Inc. All rights reserved. Subject to change without notice.



Leviton has a global presence.

If you would like to know where your local Leviton office is located please go to: www.leviton.com/international/contacts/

**Buy American Compliant Logo -- The American Recovery And Reinvestment Act of 2009 ("ARRA") provides federal grants and loans for projects throughout the country. Section 1605 of the Act, named the "Buy American" provision, requires that certain materials and manufactured products used in projects funded by the Act be manufactured in the United States. The appearance of the Recovery Act Logo in relation to a Leviton product is only intended to reflect that such product may be used in an ARRA funded project. It does not mean that such product or Leviton is sponsored or endorsed by, or that Leviton receives funds from, the federal government or the Recovery Accountability and Transparency Board. Nothing in Leviton's use of the logo is intended to suggest anything regarding the requirements for funding under ARRA.*